

POMPALAR PUMPS



HAVUZ SİRKÜLASYON POMPALARI POOL CIRCULATION PUMPS

Konut ve ticari havuzlar için yüksek performans ve güvenilirlik.
High performance and reliability for residential and commercial pools.

Doğru pompa seçimi, sistemin kalbini korur.

Proper pump selection ensures the heart of the system stays strong.

**Doğru pompa seçimi, hem filtrasyon kalitesini hem enerji verimliliğini belirler.
Neta Havuz, her havuz tipine uygun güvenilir pompa çözümleri sunar.**

*Proper pump selection ensures both filtration quality and energy efficiency.
Neta Pool offers reliable pump solutions for every pool type.*

senkron

Senkron® Pompalar

Senkron® Pumps

GÜVENİLİR PERFORMANS TRUSTED PERFORMANCE

Senkron® pompalar, 100.000'e yaklaşan satış adediyle yıllardır havuz profesyonellerinin güvenini kazanıyor. Sessiz çalışma, uzun ömür ve farklı ihtiyaçlara uygun geniş model yelpazesıyla Senkron, yerli üretimde kaliteyi temsil eder.

With nearly 100,000 units sold, Senkron® pumps have earned the trust of pool professionals for years. Offering quiet operation, long life, and a wide model range, Senkron is a symbol of quality in domestic production.

water fun → senkron



Güç
Power
0.5-12.50 HP



Debi
Flow
8-33 m³/h



Motor
IP55
Sessiz Silent



Bağlantı
Connection
Ø50-63 mm



Ses
Sound
Titreşimsiz
No Vibration



Üretim
Production
Yerli
Locally Made



Model: Senkron 1

CE

Senkron Pompalar Karşılaştırması

Senkron Pumps Comparison

Havuz Sirkülasyonu
Pool Circulation

Küçük Göletler
Small Water Pond

Süs Havuzları
Fountains

Model:	Senkron 1	Senkron 2	Senkron 3	Senkron Jet
GÜÇ POWER	0.50 - 1.50 Hp	1.50 - 4.00 Hp	4.50 - 12.50 Hp	3.00 - 4.00 Hp
BAĞLANTI CONNECTION	50 mm	63 mm	110 mm	90 mm
GÜÇ kW POWER kW	0,38 - 1,1	1,10 - 3,00	3,4 - 10,00	2,2 - 3

NEDEN SENKRON® POMPA SEÇMELİSİNİZ?

WHY CHOOSE A SENKRON® PUMP?

senkron



Motor Koruma Overheat Protection

Aşırı ısınmaya karşı koruma rölesi sayesinde motor, güvenle çalışır.

The integrated overheat protection relay ensures reliable motor operation.



Dayanıklı ve Bakım Gerektirmeyen Tasarım Durable & Maintenance-Free

Yıllarca sorunsuz kullanım.

Designed for long-lasting performance with minimal need for spare parts.



Fişli Kablo Plug-In Connection

Kullanıma hazır kablo yapısı kolay montaj sağlar.

Easy-to-install design with pre-wired power cable.



Tuzlu Suya Uyumlu Saltwater Compatible

Tuzlu su içeren havuzlar için uygundur.

Ideal for use in saltwater pools.



Kolay Bakım Easy Service Access

Ergonomik kapak anahtarı ve çift boşaltma tapası sayesinde hızlı bakım imkanı.

Dual drain plugs and ergonomic lid tool for quick serviceability.



Düşmeyen Gözetleme Camı Secure Inspection Lid

Ön kapağın düşmemesi için özel tasarlanmış gözetleme camı.

The lid stays securely in place during maintenance.



AISI 316 Paslanmaz Mil AISI 316 Stainless Steel Shaft

Korozyona dayanıklı malzeme.

Corrosion-resistant shaft for extended durability.



1½" Bağlantı Rakoru 1½" Union Connection

Standart bağlantılarla uyumlu, hızlı kurulum sağlar.

Compatible with standard fittings for easy installation.

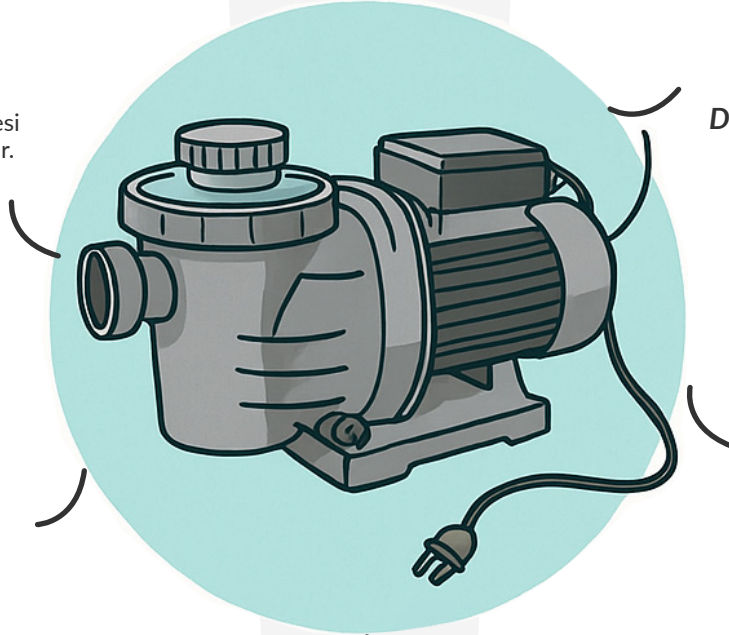

SENKRON® POMPAYI SEÇMEK İÇİN 3 NEDEN

3 REASONS TO CHOOSE SENKRON® PUMP

1. Fişli Yapı:

Kolay Kurulum

2. Sessiz ve Uzun Ömürlü Performans

3. Tuzlu Suya Dayanıklılık

1. Plug-in Design:

Easy Setup

2. Quiet and Durable Performance

3. Saltwater-resistance

ÜRÜN VİDEOSUNU
İZLEYİN

WATCH THE
PRODUCT VIDEO



MÜŞTERİ GERİ BİLDİRİMLERİ CUSTOMER FEEDBACK

Çok iyi değil, muhteşem. Daha iyisini kullanmadık.
Not so good, fabulous. We have not used better.

Senkron 1



TEMEL GÜÇ CORE POWER

Sessiz ve sağlam, giriş seviyesi havuz sistemleri için uygundur.

Silent and solid, built for entry-level pool systems. No need for spare parts.



Öne Çıkan Özellikler Product Features

- » Aşırı ısınmaya karşı koruma rölesi
- » 1 ½ bağlantı rakorları
- » Düşmeyen gözetleme camı
- » Ergonomik ön filtre kapak anahtarı
- » Fişli elektrik bağlantı kablosu
- » AISI 316 paslanmaz çelik mil
- » Çift boşaltma tapası
- » Tuzlu suda kullanılabilir
- » Over heat protection relay
- » 1 ½ 1/2" connection fittings
- » Non-falling sight glass
- » Ergonomic prefilter lid key
- » Type F power plug
- » AISI 316 stainless steel shaft
- » Double drain plug
- » Can be used in salt water

Teknik Bilgiler Technical Information

MODEL	BASMA YÜKSEKLİĞİ HEAD IN METERS					
	4	6	8	10	12	16
SEN1 0,50	20	17	15	11,7	7	-
SEN1 0,75	22	20	17,8	15,3	12,8	-
SEN1 1,00	24	22,5	20,8	20,04	16,5	7,2
SEN1 1,50	29,5	28	25,5	24	21	13,8

*8 mss basma yüksekliğinde 8 mss water column pressure

Daha fazlasını keşfedin

Senkron 1'in avantajlarını görmek için QR kodu okutun.

Discover more

Scan to explore the benefits of Senkron 1.

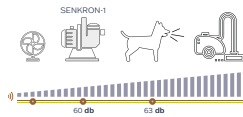

Ölçüler Dimensions

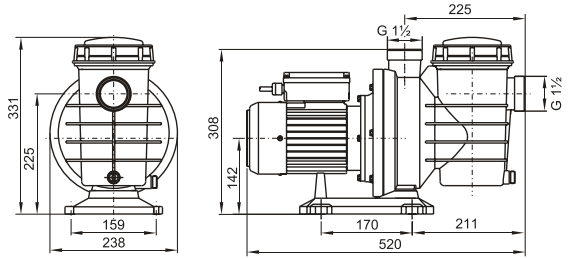

Performans Eğrisi Performance Curves

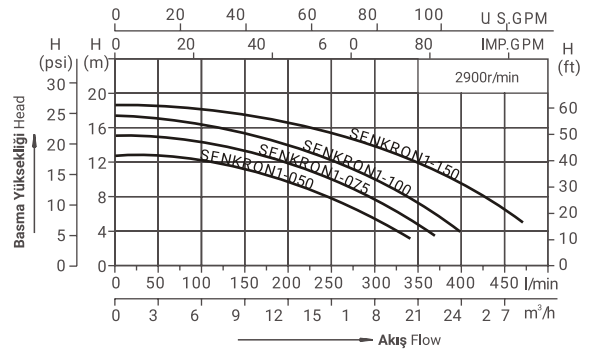

KOD CODE	MODEL MODEL	GÜÇ HP POWER HP	BAĞLANTI GİRİŞ ÇIKIŞ INLET OUTLET	DEBİ m³/h FLOW	GÜÇ KW POWER	AĞIRLIK Kg WEIGHT Kg	PAKET PACKAGE	FİYAT PRICE
11515123068	SEN1.050 M	0,50	50 mm	*15	0,38	10,6	25x55x38	253 €
11515123069	SEN1.075 M	0,75	50 mm	*17,8	0,56	11,5	25x55x38	280 €
11515123070	SEN1.100 M	1,00	50 mm	*20,8	0,75	12	25x55x38	284 €
11515123071	SEN1.100 T	1,00	50 mm	*20,8	0,75	11,6	25x55x38	286 €
11515123072	SEN1.150 M	1,50	50 mm	*25,5	1,1	12,7	25x55x38	292 €

Senkron 2



GELİŞMİŞ GÜÇ ADVANCED POWER

Sessizliği, yüksek verimi ve kolay taşınabilirliğiyle profesyonel kullanıma hazır.

Silent, efficient, and built for professional-grade performance.

 ÖZEL AMAÇLI HAVUZ
RESIDENTAL POOL

 UYGUN FİYAT
COMPETITIVE PRICE

 UZUN ÖMÜRLÜ
LONG LASTING

 TÜRK MÜHENDİSLİĞİ
TURKISH ENGINEERING

 TİP F FİŞ BAĞLANTISI
TYPE F PLUG

 SÜPER SESSİZ
SUPER SILENT

 YÜKSEK VERİMLİ
HIGH EFFICIENCY



Öne Çıkan Özellikler Product Features

- » Aşırı ısınmaya karşı koruma rölesi » Over heat protection relay
- » 2" bağlantı rakorları » 2" connection fittings
- » Düşmeyen gözetleme camı » Non-falling sight glass
- » Ergonomik ön filtre kapak anahtarı » Ergonomic prefilter lid key
- » Ergonomik tutma kolu sayesinde kolay taşınabilir » Easy to carry thanks to ergonomic handle
- » AISI 316 paslanmaz çelik mil » AISI 316 stainless steel shaft
- » Çift boşaltma tapası » Double drain plug
- » Tuzlu suda kullanılabilir » Can be used in salt water

Ölçüler Dimensions

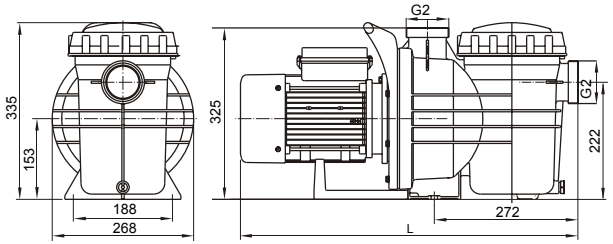

Teknik Bilgiler Technical Information

MODEL	BASMA YÜKSEKLİĞİ HEAD IN METERS					-
	6	8	10	12	16	
MODEL	DEBİ m³/h FLOW m³/h					-
SEN2 150	22,8	19,8	19,6	13,5	5,8	
SEN2 200	30	27,3	25,5	14	9	-
SEN2 300	37,5	35	33	30	23,5	-
SEN2 400	41	39	39	35	29	-

*10 mss basma yüksekliğinde 10 mss water column pressure

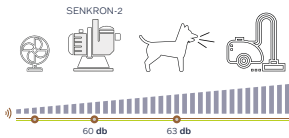

Performans Eğrisi Performance Curves

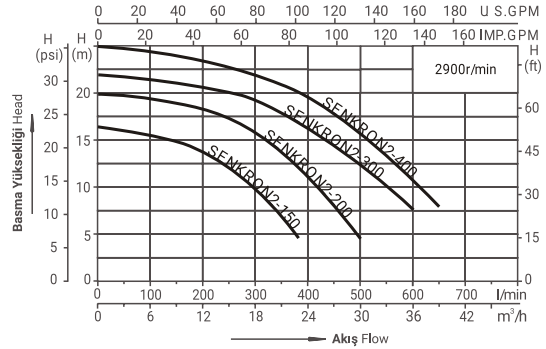

Daha fazlasını keşfedin

Senkron 2'in avantajlarını görmek için QR kodu okutun.

Discover more

Scan to explore the benefits of Senkron 2.



KOD CODE	MODEL MODEL	GÜÇ HP POWER HP	BAĞLANTI GİRİŞ ÇIKIŞ INLET OUTLET	DEBİ m³/h FLOW	GÜÇ KW POWER	AĞIRLIK Kg WEIGHT Kg	PAKET PACKAGE	FİYAT PRICE
11515123073	SEN2.150 M	1,50	63 mm	*19,6	1,10	15,5	30x66x38	353 €
11515123074	SEN2.150 T	1,50	63 mm	*19,6	1,10	15,2	30x66x38	345 €
11515123075	SEN2.200 M	2,00	63 mm	*25,5	1,50	18	30x66x38	395 €
11515123076	SEN2.200 T	2,00	63 mm	*25,5	1,50	17,2	30x66x38	385 €
11515123077	SEN2.300 M	3,00	63 mm	*33,0	2,20	20,5	30x66x38	490 €
11515123078	SEN2.300 T	3,00	63 mm	*33,0	2,20	19	30x66x38	450 €
11515123079	SEN2.400 T	4,00	63 mm	*39,0	3,00	22	30x66x38	510 €

Senkron 3



ÜSTÜN PERFORMANS PEAK PERFORMANCE

Yüksek basınç ve debi gerektiren sistemler için güçlü ve dayanıklı çözüm.

Reliable power for systems demanding high pressure and flow.



ÖZEL AMAÇLI HAVUZ
RESIDENTAL POOL



UYGUN FİYAT
COMPETITIVE PRICE



UZUN ÖMÜRLÜ
LONG LASTING



TÜRK MÜHENDİSLİĞİ
TURKISH ENGINEERING



SÜPER SESSİZ
SUPER SILENT



YÜKSEK VERİMLİ
HIGH EFFICIENCY



Öne Çıkan Özellikler Product Features

- » 4" / 100 mm bağlantı rakorları
- » Düşmeyen çerçevesi ile akuple gözetleme camı
- » Ergonomik ön filtre kapak anahtarı
- » Ergonomik tutma kolu sayesinde kolay taşınabilme
- » AISI 316 paslanmaz çelik mil
- » Çift boşaltma tapası
- » Tuzlu suda kullanılabilir
- » 4" / 100 mm connection fittings
- » Non-falling sight glass
- » Ergonomic prefilter lid key
- » Easy to carry thanks to ergonomic handle
- » AISI 316 stainless steel shaft
- » Double drain plug
- » Can be used in salt water

Ölçüler Dimensions

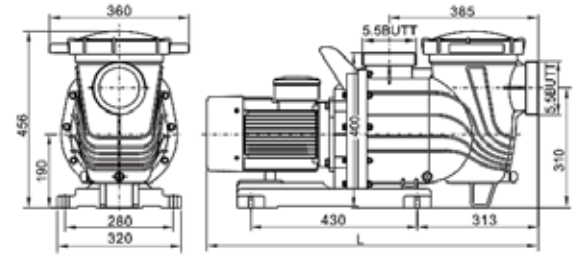

Teknik Bilgiler Technical Information

MODEL	BASMA YÜKSEKLİĞİ HEAD IN METERS				
	6	8	10	12	16
SEN3 450 T	72	63	52	42	0
SEN3 550 T	90	86	76	65	35
SEN3 750 T	98	95	91	85	66
SEN3 1000 T	-	122	114	104	82
SEN3 1250 T	136	124	116	103	-

*10 mss basma yüksekliğinde 10 mss water column pressure

Performans Eğrisi Performance Curves

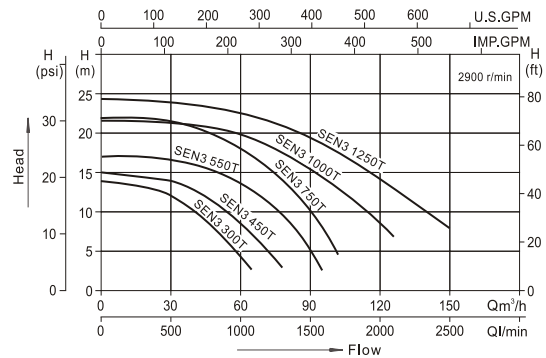

KOD CODE	MODEL MODEL	GÜÇ HP POWER HP	BAĞLANTI GİRİŞ ÇIKIŞ INLET OUTLET	AMPER AMPS	DEBİ m³/h FLOW	GÜÇ KW POWER	AĞIRLIK Kg WEIGHT Kg	PAKET PACKAGE	FİYAT PRICE
11515123082	SEN3 450 T	4,50	110 mm	230/400/50 Hz	*52	3,4	47	840x395x600	975 €
11515123083	SEN3 550 T	5,50	110 mm	400/690/50 Hz	*76	4,10	54,5	930x395x600	1.275 €
11515123085	SEN3 750 T	7,50	110 mm	400/690/50 Hz	*100	5,50	60,3	930x395x600	1.450 €
11515123086	SEN3 1000 T	10,00	110 mm	400/690/50 Hz	*124	7,50	64,5	930x395x600	1.750 €
11515123087	SEN3 1250 T	12,50	110 mm	400/690/50 Hz	*147	10,00	65	930x395x600	1.850 €

Senkron Jet



GÜÇLÜ İTİŞ POWER BOOST

Jet masajı ve su oyunları için yüksek debili güçlü pompa.
High-flow power pump for jet massage and water features.



Öne Çıkan Özellikler Product Features

- » Aşırı ısınmaya karşı koruma rölesi
- » 3" bağlantı rakorları
- » Düşmeyen gözetleme camı
- » Ergonomik ön filtre kapak anahtarı
- » AISI 316 paslanmaz çelik mil
- » Çift boşaltma tapası
- » Tuzlu suda kullanılabilir
- » Over heat protection relay
- » 3" connection fittings
- » Non-falling sight glass
- » Ergonomic prefilter lid key
- » AISI 316 stainless steel shaft
- » Double drain plug
- » Can be used in salt water

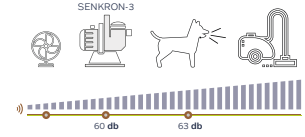

Teknik Bilgiler Technical Information

	BASMA YÜKSEKLİĞİ HEAD IN METERS				
	8	10	12	14	16
	DEBİ m³/h FLOW m³/h				
SENJET 300T	72	62	46	25	0
SENJET 400T	80	76	66	52	30

*10 mss basma yüksekliğinde 10 mss water column pressure

Performans Eğrisi Performance Curves

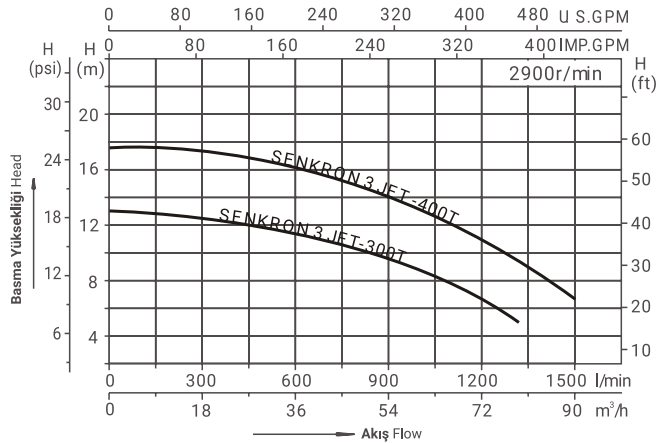

KOD CODE	MODEL MODEL	GÜÇ HP POWER HP	BAĞLANTI GİRİŞ ÇIKIŞ INLET OUTLET	DEBİ m³/h FLOW	GÜÇ KW POWER	AĞIRLIK Kg WEIGHT Kg	PAKET PACKAGE	FİYAT PRICE
11515123080	SENJET 300T	3,00	90 mm	*46	2.2	22	635x300x44	570 €
11515123081	SENJET 400T	4,00	90 mm	*66	3	25,3	675x300x44	585 €

Trione Storm



İYİ PERFORMANS COMPACT POWER

Küçük ve yer üstü havuzlar için tasarlanan Trione Storm, dar alanlara kolayca uygulanır ve yüksek verim sunar.

Designed for small and above-ground pools, Trione Storm fits narrow spaces with ease and delivers high efficiency.

ÖZEL AMAÇLI HAVUZ
RESIDENTIAL POOL

TIP F FİŞ BAĞLANTISI
TYPE F PLUG

UZUN ÖMÜRLÜ
LONG LASTING

YÜKSEK VERİMLİ
HIGH EFFICIENCY



CE



Öne Çıkan Özellikler Product Features

- » Küçük havuzlar ve / veya yer üstü havuzları için dizayn edilmiştir
- » Tuzlu suda kullanılabilir
- » Kompakt tasarımı sayesinde dar alanlarda uygulama avantajı sağlar
- » Etkileyici fiyat performans ilişkisi
- » Su geçirmezlik seviyesi IPX5
- » Dijital zamanlayıcı ve açma-kapama paneli
- » Type F fiş bağlantısı

- » Pump designed for small pools and /or above ground pool
- » Can be used in salt water
- » Thanks to its compact design, it offers an advantage in applications within narrow spaces
- » Impressive price-performance ratio
- » Waterproof level IPX5
- » Dijital timer and on-off panel
- » Type F power plug

Teknik Bilgiler Technical Information

Model	Q Max.	H Max.
STORM 0,75	11 m ³ /h	11 meters
STORM 1,00	13 m ³ /h	12 meters

Tak ve Çalıştır Kolaylığı

Type F fiş bağlantısıyla montaj gerektirmeden hemen kullanıma hazır.

Plug & Play Convenience

With its Type F plug connection, it's ready to use instantly – no installation required.



Ölçüler Dimensions

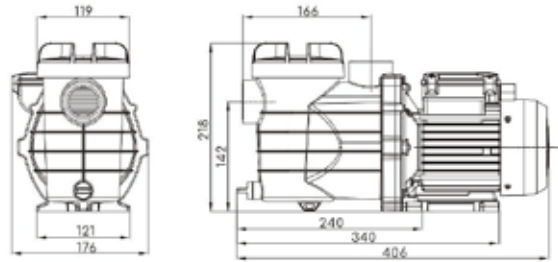

Kullanım kılavuzuna ulaşmak için QR kodu okutun.



Scan the QR code to access the user manual.

KOD CODE	MODEL MODEL	GÜÇ HP POWER HP	BAĞLANTI GİRİŞ ÇIKIŞ INLET OUTLET	DEBİ m ³ /h FLOW max	AĞIRLIK Kg WEIGHT Kg	PAKET UxGxY PACKAGE LxWxH	FİYAT PRICE
11515124001	Storm 0,75	0,75	50 mm Dişli Threaded	*11	5,4	40,4x17,7x21,8 cm	184 €
11515124002	Storm 1.00	1,00	50 mm Dişli Threaded	*13	5,9	40,4x17,7x21,8 cm	194 €



Kripsol Pompa Serisi

Kripsol Pump Series

50 yılı aşkın geçmişiyle Avrupa'da tanınan Kripsol pompaları, Neta Havuz güvencesiyle şimdi Türkiye'de. Geniş model yelpazesi ve dayanıklı yapısıyla havuz projelerinde sıkça tercih ediliyor.

With over 50 years of history, Kripsol pumps are well-known across Europe – now available in Turkey with the assurance of Neta Havuz. Widely preferred in pool projects for their durable construction and broad model range.



Ninfa NK



KOMPAKT GÜÇ COMPACT POWER

Küçük hacimli havuzlar için tasarlanmış, tuzlu suya dayanıklı, sessiz ve güvenilir performans.

Designed for small pools, this saltwater-resistant pump offers quiet and reliable performance.



Öne Çıkan Özellikler Product Features

- » Yer üstü veya küçük ebatlı ev havuzları için çözüm sunar
- » Kolay açılır şeffaf kapak. (Alet gerektirmez)
- » Bağlantı 2" dıştan dişli, 1 1/4" içten dişli
- » Mekanik salmastra AISI 316 kalite
- » Motor sürüş özellikleri Class F, IP55, 50 Hz
- » 35 m³'e kadar olan ev havuzlarında kullanılır
- » Tuzlu suda kullanılabilir
- » The solution for above-ground pools or small size residential pools
- » Easy-open transparent lid. (No tools required)
- » Connection thread 2" external and 1 1/4" internal
- » Mechanical seal in AISI 316 quality
- » Motor-drive specifications Class F, IP55, 50 Hz
- » Used for residential pools up to 35 m³
- » Can be used in salt water

Ölçüler Dimensions

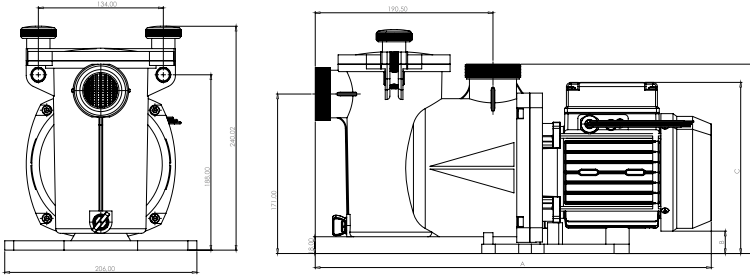

Kullanım kılavuzuna ulaşmak için QR kodu okutun.

Scan the QR code to access the user manual.



Teknik Bilgiler Technical Information

MODEL	BASMA YÜKSEKLİĞİ HEAD IN METERS									
	3	4	5	6	7	8	9	10	10,5	11
MODEL	DEBİ m ³ /h FLOW m ³ /h									
NK 25.B	8	7,3	6,7	6	5,1	4	2,1	-	-	-
NK 33.B	11	10,2	9,3	8,4	7,5	6,4	5,3	4	3,1	0
NK 51.B	13,2	12,1	11	9,75	8,6	7,5	6,1	4,3	3,4	0

*8 mss basma yüksekliğinde 8 mss water column pressure

Performans Eğrisi Performance Curves

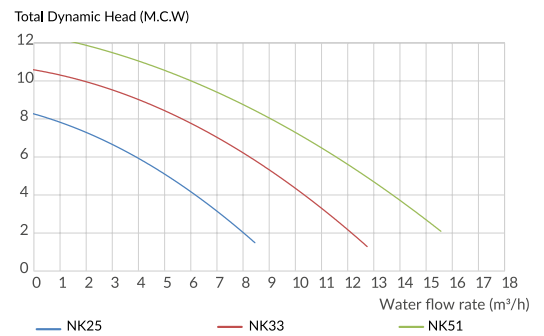

KOD CODE	MODEL MODEL	GÜÇ HP POWER HP	BAĞLANTI GİRİŞ ÇIKIŞ INLET OUTLET	DEBİ m ³ /h FLOW	GÜÇ KW POWER	AĞIRLIK Kg WEIGHT Kg	SES ŞİDDETİ SOUND	FİYAT PRICE
			Dış Outside İç Inside					
11515113054	NK 25.B	0,25	63 mm 40 mm	*4,00	0,27	5,6	51,6	275 €
11515113067	NK 33.B	0,33	63 mm 40 mm	*6,40	0,36	6	56,0	355 €
11515113076	NK 51.B	0,50	63 mm 40 mm	*7,50	0,53	6,3	59,0	380 €

Ondina OK



DAYANIKLI TASARIM ERGONOMIC BUILD

Yoğun kullanıma uygun gövdesi ve pratik taşıma yapısı ile profesyonel havuz projelerinde öne çıkar.

Durable body and ergonomic grip, ideal for demanding pool setups.

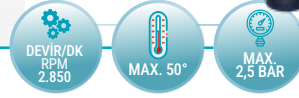

Öne Çıkan Özellikler

Product Features

- » 3" bağlantı rakorları
- » Düşmeyen gözetleme camı
- » Ergonomik ön filtre kapak anahtarı
- » Ergonomik tutma kolu sayesinde kolay taşınabilir
- » AISI 316 paslanmaz çelik mil
- » Çift boşaltma tapası
- » Tuzlu suda kullanılabilir
- » 3" connection fittings
- » Non-falling sight glass
- » Ergonomic prefilter lid key
- » Easy to carry thanks to ergonomic handle
- » AISI 316 stainless steel shaft
- » Double drain plug
- » Can be used in salt water

Kullanım kılavuzuna ulaşmak için QR kodu okutun.



Scan the QR code to access the user manual.

Ölçüler Dimensions

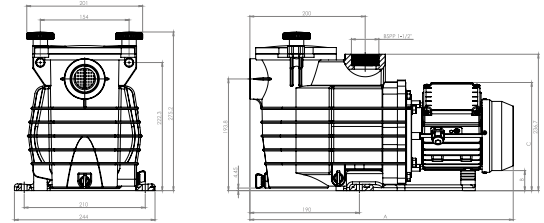

Teknik Bilgiler Technical Information

MODEL	BASMA YÜKSEKLİĞİ HEAD IN METERS						
	5	6	8	10	11	12	14
OK 33.B	9,6	8,9	7	4,8	3	-	-
OK 51.B	11	10,1	8,5	6,6	5,2	4	-
OK 71.B	13,9	13,2	11,9	10	9	7,5	3,5
OK 100.B	20	19,2	17,2	14,5	12,9	10,5	5,5

*8 mss basma yüksekliğinde 8 mss water column pressure

Performans Eğrisi Performance Curves

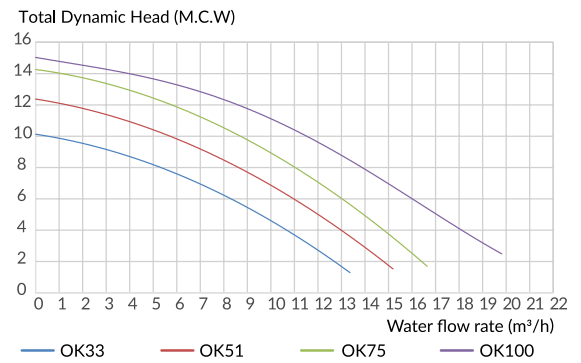

KOD CODE	MODEL MODEL	GÜÇ HP POWER HP	BAĞLANTI GİRİŞ ÇIKIŞ INLET OUTLET	DEBİ m³/h FLOW	GÜÇ KW POWER	SES ŞİDDETİ DP SOUND DP	AĞIRLIK Kg WEIGHT Kg	FİYAT PRICE
11515113083	OK 33 M	0,33	50 mm	*7,00	0,27	53,3	8	335 €
11515113084	OK 51 T	0,50	50 mm	*8,50	0,58	54,2	8,5	418 €
11515113085	OK 50 M	0,50	50 mm	*8,50	0,58	54,2	8,5	355 €
11515113086	OK 71 M	0,75	50 mm	*11,90	0,75	57,2	9	475 €
11515113087	OK 71 T1	0,75	50 mm	*11,90	0,75	57,2	9	440 €
11515113088	OK 100 M	1,00	50 mm	*17,20	1,00	59,2	11,5	540 €
11515113089	OK 100 T1	1,00	50 mm	*17,20	1,00	59,2	11,5	485 €
198114018	OK 050 IE2	0,50	50 mm	*8,50	0,58	54,2	8,5	418 €

S2 Model



AKILLI TASARIM SMARTLY ENGINEERED

Kompakt yapısı, pratik çözümleri ve güçlü performansı ile küçük havuzlara özel, kullanıcı dostu bir pompa.

Compact, practical and powerful – a user-friendly pump for small pools.

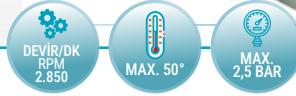

Öne Çıkan Özellikler

Product Features

- » Küçük havuzlar ve / veya yer üstü havuzları için dizayn edilmiştir
- » 80 m³e kadar olan havuzlarda kullanılır
- » Tuzlu suda kullanılabilir
- » Pump designed for small pools and /or above ground pool
- » Used for residential pools up to 80 m³
- » Can be used in salt water

Ölçüler Dimensions

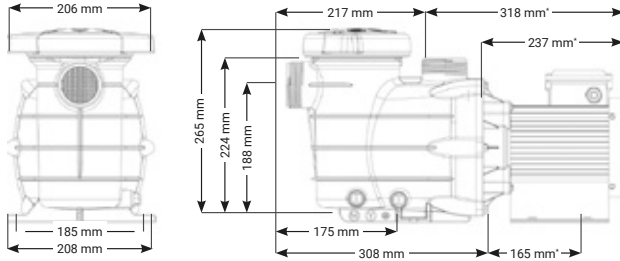

Teknik Bilgiler Technical Information

MODEL	BASMA YÜKSEKLİĞİ HEAD IN METERS					
	4	6	8	10	12	14
S2 33.M	11,2	9,4	7,3	5	2	-
S2 50.M	14,8	13	10,8	8,5	5,4	-
S2 75.M	17,4	15,2	13	11,1	7,5	-
S2 100.M	19,5	17,8	15	13,2	7,3	5,8
S2 150.M	21,2	19	17,2	15,6	11,8	7,8

*8 mss basma yüksekliğinde 8 mss water column pressure

Performans Eğrisi Performance Curves

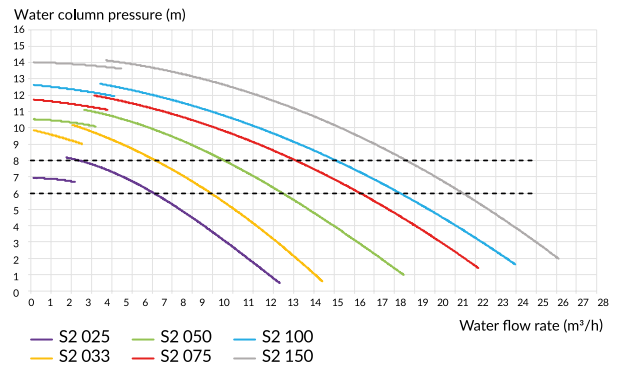

KOD CODE	MODEL MODEL	GÜÇ HP POWER HP	BAĞLANTI GİRİŞ ÇIKIŞ INLET OUTLET	DEBİ m ³ /h FLOW	GÜÇ KW POWER	AĞIRLIK Kg WEIGHT Kg	FİYAT PRICE
11515113148	S2.33 M	0,33	50 mm	*7,03	0,45	7,76	330 €
11515113146	S2.50 M	0,50	50 mm	*10,80	0,58	8,85	350 €
11515113147	S2.75 M	0,75	50 mm	*13,00	0,75	9,16	370 €
11515113150	S2.100 M	1,00	50 mm	*15,00	0,90	9,16	420 €
11515113145	S2.150 M	1,50	50 mm	*17,20	1,10	11,30	440 €

Koral KSE



KLASİK GÜÇ THE ORIGINAL POWER

Yüksek debisi, sessiz hidrolik sistemi ve farklı bağlantı seçenekleriyle her havuza uyum sağlayan klasik bir çözüm.

A quiet and powerful classic with high flow and versatile connection options for every pool.

ÖZEL AMAÇLI HAVUZ
RESIDENTIAL POOL

UZUN ÖMÜRLÜ
LONG LASTING

DÜNYA MARKASI
GLOBAL BRAND

BİR KLASİK
THE ORIGINAL



CE

DEVİR/DK
RPM
2.850

MAX. 50°

MAX.
2,5 BAR

Kullanım kılavuzuna ulaşmak için QR kodu okutun.



Scan the QR code to access the user manual.

Öne Çıkan Özellikler Product Features

- » Optimize edilmiş süper sessiz hidrolik sistem
- » Kelebek somun ile kolay kapanan şeffaf ön filtre
- » Korozyona dayanıklı fan, kolay açılabilen çift drenaj
- » Bağlantılar: \varnothing 50 veya \varnothing 63 mm yapılandırma rakorları içerir
- » Motor sürüş özellikleri Class F, IP55, 50 Hz
- » 177 m³e kadar olan havuzlarda kullanılır, Tuzlu suda kullanılabilir
- » Optimized super silent hydraulic system
- » Easy accessible and visible pre-filter
- » Corrosion resistant impeller, easy opening double drainage
- » Connections: includes slip unions for \varnothing 50 or \varnothing 63 mm
- » Motor-drive specifications Class F, IP55, 50 Hz
- » Used for residential pools up to 177 m³, Can be used in salt water

Ölçüler Dimensions

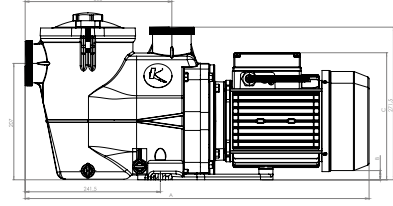
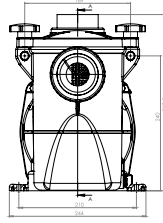

Teknik Bilgiler Technical Information

MODEL	BASMA YÜKSEKLİĞİ HEAD IN METERS								
	5	6	8	10	11	12	14	16	18
KS 33.B	11	8,9	7	4,8	3	-	-	-	-
KS 50.B	14,5	12	10	7,56	5,2	5,1	-	-	-
KS 75.B	16	14,5	13,5	11,5	10,2	8,9	5,21	-	-
KS 100.B	21,5	19,5	17,5	15,4	14,2	13	10	5,8	1
KS 150.B	27,5	25,5	23	21,9	20,8	19,7	16,4	11,8	6,2
KS 200.B	32	29,4	27,8	25,7	24,6	23,52	0,51	71	2
KS 300.B	36,5	34,5	32	29,5	28,2	26,9	23,9	20	20

Performans Eğrisi Performance Curves

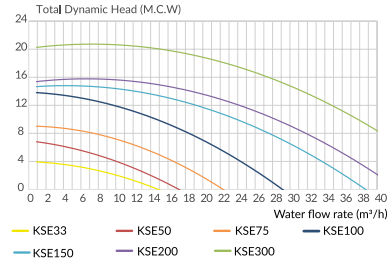

*10 mss basma yüksekliğinde
10 mss water column pressure

KOD CODE	MODEL MODEL	GÜÇ HP POWER HP	BAĞLANTI GİRİŞ ÇIKIŞ INLET OUTLET	DEBİ m³/h FLOW	GÜÇ KW POWER	SES ŞİDDETİ DP SOUND DP	AĞIRLIK Kg WEIGHT Kg	FİYAT PRICE
11515113090	KSE.33 M	0,33	63 mm	*4,08	0,45	54,6	11,2	438 €
11515113091	KSE.50 M	0,50	63 mm	*7,50	0,58	59,6	12,5	480 €
11515113092	KSE.50 T1	0,50	63 mm	*7,50	0,58	59,6	12	480 €
11515113173	KSE.75 M M IE2	0,75	63 mm	*11,50	0,75	60,8	13,5	645 €
11515113094	KSE.75 T1	0,75	63 mm	*11,50	0,75	60,8	13	625 €
11515113095	KSE.100 M	1,00	63 mm	*15,40	1,00	65,6	14	645 €
11515113096	KSE.100 T1	1,00	63 mm	*15,40	1,00	65,6	13,5	685 €
11515113156	KSE.150 M IE2	1,50	63 mm	*21,90	1,50	65,6	16,5	750 €
11515113098	KSE.150 T1	1,50	63 mm	*21,90	1,50	65,6	16	755 €
11515113099	KSE.200 M	2,00	63 mm	*25,70	2,00	66,0	17,5	800 €
11515113100	KSE.200 T1	2,00	63 mm	*25,70	2,00	66,0	17	845 €
11515113165	KSE.200 T IE3	2,00	63 mm	*25,70	2,00	66,0	17,5	--
11515113132	KSE.300 T1 IE3	3,00	63 mm	*29,51	3,00	66,7	22	1.105 €
11515113159	KSE.300 M IE2	3,00	63 mm	*29,50	3,00	67,7	22	1.115 €
11515113149	KSE.300 M	3,00	63 mm	*29,50	3,00	67,7	22	1.035 €

Niger KNG



SPA UZMANI SPA SPECIALIST

Hydro masaj ve sirkülasyon sistemleri için ideal, sessiz çalışan ve tuzlu suya dayanıklı pompa.

Ideal for hydro massage and circulation systems, this silent pump performs reliably even in saltwater.



Öne Çıkan Özellikler Product Features

- » Hidro masaj, SPA ve su oyunları havuzları için sirkülasyonda kullanılır
- » Noryl fan ve AISI 316 paslanmaz mekanik salmastra
- » Kapalı tip motor koruma sınıfı IP55, class F, 50 Hz
- » Ø50 mm iç veya Ø63 mm dış yapıştırma bağlantı
- » Sessiz çalışma
- » Tuzlu suda kullanılabilir

- » Used in hydro massage, spas and general re-circulation
- » Impeller in noryl and mechanical seal in AISI 316
- » Enclosed motor, protection class IP55, class F, 50 Hz
- » Slip included: Ø50 or Ø63 mm
- » Silent operation
- » Can be used in salt water

Kullanım kılavuzuna ulaşmak için QR kodu okutun.



Scan the QR code to access the user manual.

Ölçüler Dimensions

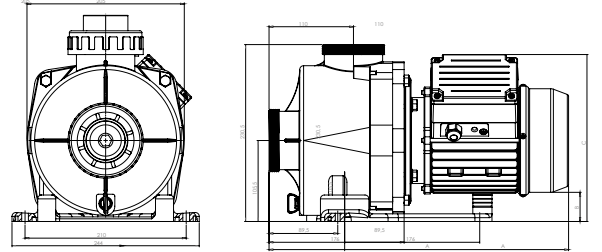

Teknik Bilgiler Technical Information

MODEL	BASMA YÜKSEKLİĞİ HEAD IN METERS								
	5	6	8	10	11	12	14	16	18
KNG 075.B	16,5	15,4	14	12	10,7	9,4	5,7	-	-
KNG 100.B	22	20	18	15,9	14,7	13,5	13,5	6,3	-
KNG 150.B	28	26	23,5	22,4	21,3	20,2	20,2	2,31	6,7
KNG 200.B	32,5	29,9	28,3	26,2	25,1	24	24	17,5	12,5

*10 mss basma yüksekliğinde 10 mss water column pressure

Performans Eğrisi Performance Curves

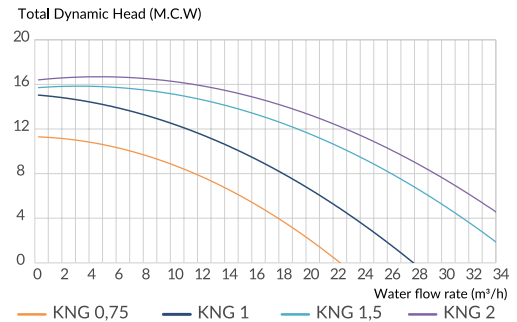

KOD CODE	MODEL MODEL	GÜÇ HP POWER HP	BAĞLANTI GİRİŞ ÇIKIŞ INLET OUTLET	DEBİ m³/h FLOW	GÜÇ KW POWER	SES ŞİDDETİ DP SOUND DP	AĞIRLIK Kg WEIGHT Kg	FİYAT PRICE
			Diş Outside İç Inside					
11515113154	KNG.075 DM	0,75	50 mm 63 mm	*12	0,75	59,4	11,5	412 €
11515113114	KNG.075 DT1	0,75	50 mm 63 mm	*12	0,75	59,4	11,5	412 €
11515113115	KNG.100 DM	1,00	50 mm 63 mm	*15,98	1,00	59,2	12	465 €
11515113117	KNG.150 DM	1,50	50 mm 63 mm	*22,4	1,60	65	14,5	513 €
11515113119	KNG.200 DM	2,00	50 mm 63 mm	*26,2	1,92	66	15,5	556 €
11515113116	KNG.100 DT1	1,00	50 mm 63 mm	*15,9	1,00	59,2	12	465 €
11515113118	KNG.150 DT1	1,50	50 mm 63 mm	*22,4	1,60	65	14,5	513 €
10771150120	KNG 150 DT1 IE3	1,50	50 mm 63 mm	*22,4	1,60	65	14,5	--
11515113120	KNG 200 DT1	2,00	50 mm 63 mm	*26,2	1,92	66	15	535 €

Kapri KAP



YÜKSEK DEBİ HIGH FLOW

Endüstriyel projeler ve büyük havuzlar için yüksek debi kapasitesi ve dayanıklılığıyla öne çıkar.

Stands out with high flow capacity and durability for industrial projects and large pools.

ÖZEL AMAÇLI HAVUZ
RESIDENTAL POOL

DÜNYA MARKASI
GLOBAL BRAND

UZUN ÖMÜRLÜ
LONG LASTING

YÜKSEK VERİMLİ
HIGH EFFICIENCY

ÖN FİLTRE KAPASİTE
PRE FILTER CAPACITY
8 LT

KATEGORİSİNDE EN İYİ
THE BEST IN ITS
CATEGORY



Öne Çıkan Özellikler Product Features

- » Termoplastik enjeksiyonlu pompa gövdesi
- » Yüksek kapasiteli ön filtre
- » Şeffaf polikarbonat ön filtre kapağı. KAPRI serisinin kapağı 4 adet menteşeli kelebek somun ile kolayca kapanır
- » Noryl fan ve flanş fiberglass takviyeli
- » Motor koruma sınıfı IP55, class F, 50 Hz
- » Mekanik salmastra AISI 316 kalite
- » Tuzlu suda kullanılabilir

- » Thermoplastic injected pump casing
- » High capacity prefilter
- » Prefilter lid in transparent polycarbonate. The closing of the lid for KAPRI series is made by four hinged cover-screws with stainless steel studs
- » Impeller and flange in Noryl charged with fiber glass
- » Motor, protection class IP55, class F, 50 Hz
- » Mechanical seal in AISI 316 quality
- » Can be used in salt water

Teknik Bilgiler Technical Information

MODEL	BASMA YÜKSEKLİĞİ HEAD IN METERS							
	6	8	10	12	14	16	18	20
MODEL	DEBİ m³/h FLOW m³/h							
KAP 250.B	52	47	41	35	28	-	-	-
KAP 300.B	60	54	48	42	35	26	-	-
KAP 350.B	73	65	58	50	41	28	-	-
KAP 450.B	79	74	66	57	47	36	20	-
KAP 550.B	86	88	76	67	52	52	28	-

*10 mss basma yüksekliğinde 10 mss water column pressure

Ölçüler Dimensions

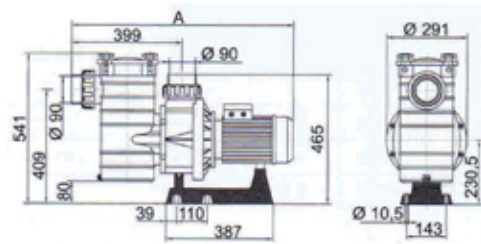

KOD CODE	MODEL MODEL	GÜÇ HP POWER HP	BAĞLANTI GİRİŞ ÇIKIŞ INLET OUTLET	DEBİ m³/h FLOW	GÜÇ KW POWER	SES ŞİDDETİ DP SOUND DP	AĞIRLIK Kg WEIGHT Kg	FİYAT PRICE
11515113102	KAP250 M.B	2,50	90 mm	*41	2,3	65,2	-	1.298 €
11515113103	KAP250 Tri	2,50	90 mm	*41	2,3	65,2	-	1.515 €
11515113104	KAP300 M	3,00	90 mm	*48	2,76	65,8	-	1.370 €
11515113105	KAP300 T1.B	3,00	90 mm	*48	2,76	68,4	-	1.530 €
11515113106	KAP350 T1.B	3,50	90 mm	*58	3,7	-	-	1.648 €
11515113053	KAP450 T1.B	4,50	90 mm	*66	4,3	-	-	1.678 €
11515113107	KAP550 T1.B	5,50	90 mm	*76	4,71	-	-	1.750 €

Karpa KA



JET PERFORMANSI JET PERFORMANCE

Jet stream, spa ve büyük havuzlarda yüksek debiyle sessiz ve güçlü sirkülasyon sağlar.

Provides powerful and silent circulation with high flow for jet streams, spas, and large pools.



Öne Çıkan Özellikler Product Features

- » Kullanım Alanları: Hidromasaj havuzları, spalar, jet stream ve genel havuzlar için sirkülasyon
- » Sessiz çalışma
- » Motor sürüş özellikleri Class F, IP55, 50 Hz
- » Mekanik salmastra AISI 316 kalite
- » Pompa gövdesi sertleştirilmiş yapıda
- » Tuzlu suda kullanılabilir

- » Usage Areas: Hydromassage pools, spas, jet stream and circulation for public pools
- » Silent operation
- » Motor-drive specifications Class F, IP55, 50 Hz
- » Mechanical seal in AISI 316 quality
- » Pump housing in hardened thermoplastic
- » Can be used in salt water

Kullanım kılavuzuna ulaşmak için QR kodu okutun.



Scan the QR code to access the user manual.

Ölçüler Dimensions

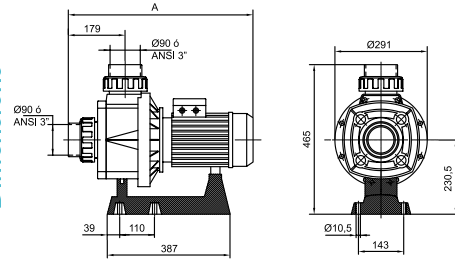

Teknik Bilgiler Technical Information

MODEL	BASMA YÜKSEKLİĞİ HEAD IN METERS							
	6	8	10	12	14	16	18	20
KA 250.B	54	50	44	39	30	00	-	-
KA 300.B	60	54	48	42	37	20	-	-
KA 350.B	78	71	63	54	45	21	-	-
KA 450.B	84	76	67	58	47	27	-	-
KA 550.B	93	85	78	68	59	47	30	-

*10 mss basma yüksekliğinde 10 mss water column pressure

Performans Eğrisi Performance Curves

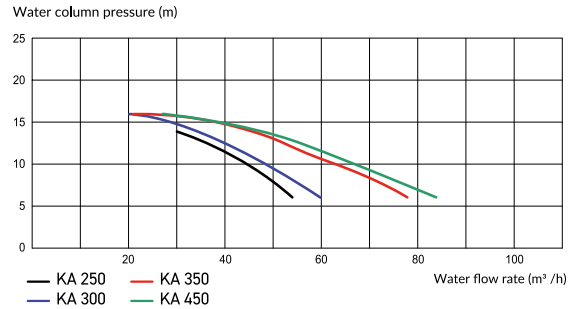

KOD CODE	MODEL MODEL	GÜÇ HP POWER HP	BAĞLANTI GİRİŞ ÇIKIŞ INLET OUTLET	DEBİ m ³ /h FLOW	GÜÇ KW POWER	SES ŞİDDETİ DP SOUND DP	AĞIRLIK Kg WEIGHT Kg	FİYAT PRICE
11515113121	KA 250.B M	2,50	90 mm	*44	2,3	65,2	20,8	1.140 €
11515113122	KA 250.B T1	2,50	90 mm	*44	2,3	65,2	20,8	1.120 €
11515113123	KA 300.B M	3,00	90 mm	*48	2,76	65,8	21,5	1.210 €
11515113124	KA 300.B T1	3,00	90 mm	*48	2,76	65,8	21,5	1.170 €
11515113125	KA 350.B T1	3,50	90 mm	*63	3,7	65,4	-	1.230 €
11515113126	KA 450.B T1	4,50	90 mm	*67	4,3	-	-	1.290 €
11515113127	KA 550.B T1	5,50	90 mm	*78	4,71	-	-	1.350 €
11515113128	KA 550.B T2	5,50	90 mm	*78	4,71	-	-	1.350 €

Prime KPR



GENİŞ KAPASİTE LARGE CAPACITY

Büyük hacimli havuzlar için güçlü ve uzun ömürlü pompa.

Powerful and long-lasting pump for large-volume pools.

ÖZEL AMAÇLI VE
KÜÇÜK TİCARİ HAVUZ
RESIDENTIAL &
SMALL COMMERCIAL
POOL

DÜNYA MARKASI
GLOBAL BRAND

UZUN ÖMÜRLÜ
LONG LASTING

GÜÇLÜ & ÇOK YÖNLÜ
POWERFUL & VERSATILE

ÖN FİLTRE KAPASİTE
PRE FILTER CAPACITY
5 LT

YÜKSEK VERİMLİ
HIGH EFFICIENCY

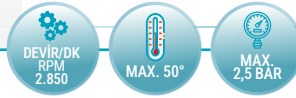

Öne Çıkan Özellikler Product Features

- » Büyük konut havuzları veya küçük ticari havuzlarda, su terapisi jetlerinde kullanılır
- » Büküm kilit sistemi sayesinde kolay kapanır ve geniş açılı şeffaf ön filtre kapağı
- » Noryl fan ve AISI 316 paslanmaz mekanik salmastra
- » Sağlam, korozyona dayanıklı tasarım
- » 270 m³'e kadar olan konut havuzlarında kullanılır
- » Tuzlu suda kullanılabilir

- » Used in large residential pools or small public pools and in aqua therapy jets
- » The transparent cover with a rapid twist-lock cover provides a view into the interior of the pre filter and provides easy access
- » Impeller in Noryl and mechanical seal in AISI 316
- » Robust, corrosion-resistant design
- » For residential pools up to 270 m³
- » Can be used in salt water

Ölçüler Dimensions

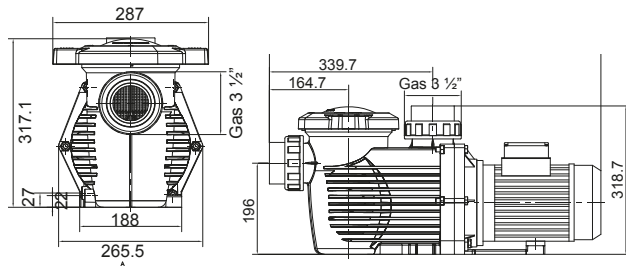

Kullanım kılavuzuna ulaşmak için QR kodu okutun.

Scan the QR code to access the user manual.



Büküm kilit kapağı
Twist lock cover



Rakor ø75 mm
yapıştırma
Union ø75 mm slip



5 Litreden fazla ön filtre kapasitesi
More than 5 liter strainer

Teknik Bilgi Technical Information

MODEL	BASMA YÜKSEKLİĞİ HEAD IN METERS										
	6	8	10	12	14	16	18	20	22	24	26
KPR 250.B	36	33	30	26	24	19	16	10	3	-	-
KPR 300.B	40	38	36	34	32	28	25	62	16	6	-
KPR 350.B	49	47	45	43	41	38	35	2	27	21	10

*10 mss basma yüksekliğinde 10 mss water column pressure

Performans Eğrisi Performance Curves

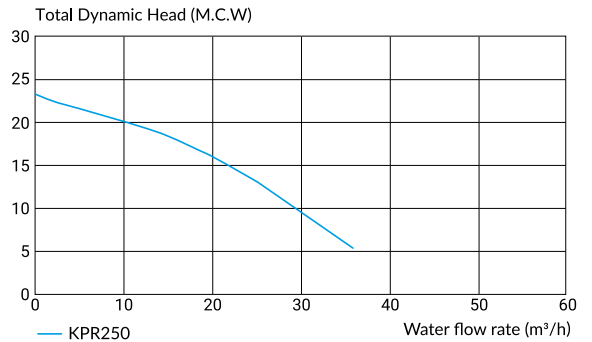

KOD CODE	MODEL MODEL	GÜÇ HP POWER HP	BAĞLANTI GİRİŞ ÇIKIŞ INLET OUTLET	DEBİ m³/h FLOW	GÜÇ KW POWER	SES ŞİDDETİ DP SOUND DP	AĞIRLIK Kg WEIGHT Kg	FİYAT PRICE
11515113143	KPR.250 M	2,50	75 mm	*30	2,4	-	24	865 €
11515113142	KPR.250 T1	2,50	75 mm	*30	2,4	-	28,5	784 €
11515113139	KPR.300 M	3,00	75 mm	*36	2,8	-	26	879 €
11515113138	KPR.300 T1	3,00	75 mm	*36	2,8	-	28,5	827 €
11515113140	KPR.350 T1	3,50	75 mm	*45	3,8	-	31,5	898 €

Kan Plus

AĞIR HİZMET PERFORMANSI HEAVY-DUTY PERFORMANCE

Yüksek debili ticari havuzlar için güçlü ve dayanıklı çözüm.

Powerful and durable solution for high-flow commercial pools.

TİCARİ HAVUZ
COMMERCIAL POOL

UZUN ÖMÜRLÜ
LONG LASTING

DÜNYA MARKASI
GLOBAL BRAND

YÜKSEK VERİMLİ
HIGH EFFICIENCY

ÖN FİLTRE KAPASİTE
PRE FILTER CAPACITY
14 LT

CE



MADE IN
SPAIN



Öne Çıkan Özellikler Product Features

- » Termoplastik plastik enjeksiyonlu pompa gövdesi
- » Yüksek kapasiteli ön filtre
- » Şeffaf polikarbonat ön filtre kapağı
- » KAN serisinin kapağının kapatılması, paslanmaz çelik saplamalı dört menteşeli kapak vidası ile sağlanmıştır.
- » 3 Kg/cm² basınca dayanabilen desteklenmiş pompa gövdesi, kapak ve pim
- » Noryl fan ve AISI 316 paslanmaz mekanik salmastra
- » Motor koruma sınıfı IP55, class F, 50 Hz
- » Tuzlu suda kullanılabilir
- » Thermoplastic plastic injected pump casing
- » High capacity prefilter
- » Prefilter lid in transparent polycarbonate
- » The closing of the lid for KAN series is made by four hinged cover-screws with stainless steel studs
- » Pump casing, lid and pin reinforced to reach 3 Kg/cm² working pressure
- » Impeller in Noryl and mechanical seal in AISI 316
- » Motor, protection class IP55, class F, 50 Hz
- » Can be used in sea water

Teknik Bilgiler Technical Information

MODEL	BASMA YÜKSEKLİĞİ HEAD IN METERS									
	8	10	11	12	13	14	16	18	20	22
KAN 500.B	90	80	72	64	56	47,5	39,9	22,6	-	-
KAN 600.B	94,5	90	87	84,2	80	75,5	59	46,2	36	-
KAN 750.B	122	113	108	102	95	89	74	53	36,5	-
KAN 1000.B	135	125,4	120,4	115,6	110,5	105,5	83,9	57	32,5	-
KAN 1250.B	152	143	140	137	126	47	118	106	93	80

*10 mss basma yüksekliğinde 10 mss water column pressure

Ölçüler Dimensions

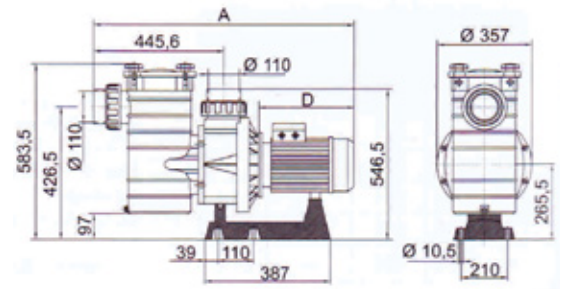

KOD CODE	MODEL MODEL	GÜÇ HP POWER HP	BAĞLANTI GİRİŞ ÇIKIŞ INLET OUTLET	DEBİ m ³ /h FLOW	GÜÇ KW POWER	SES ŞİDDETİ DP SOUND DP	AĞIRLIK Kg WEIGHT Kg	FİYAT PRICE
11515113108	KAN 510 T2B	5,50 Tri	110 mm	*80	5,5	80	45	1.778 €
11515113109	KAN 610 T2B	6,50 Tri	110 mm	*90	6,5	82	46	2.018 €
11515113110	KAN 760 T2B	7,50 Tri	110 mm	*113	7,5	85	52	2.990 €
11515113111	KAN 1020 T2B	10,0 Tri	110 mm	*125	10	87	66	3.100 €
11515113112	KAN 1270 T2B	12,50 Tri	110 mm	*143	12,5	87	76	3.039 €
11515113155	KAN 1020 T2B IE3	10,00 Tri	110 mm	*125	10	87	66	3.475 €
11515113160	KAN 1270 T2B IE3	12,50 Tri	110 mm	*143	12,5	87	76	3.850 €

KSE-VS 150



AKILLI PERFORMANS SMART PERFORMANCE

Sessiz, verimli ve programlanabilir havuz pompası.

Silent, efficient and programmable pool pump.



ÖZEL AMAÇLI VE
KÜÇÜK TİCARİ HAVUZ
RESIDENTIAL %
SMALL COMMERCIAL
POOL

DÜNYA MARKASI
GLOBAL BRAND

UZUN ÖMÜRLÜ
LONG LASTING



Öne Çıkan Özellikler Product Features

- » Değişken hız: Her uygulama için yüksek verim, optimize edilmiş tüketim
- » 5 program, 3 önceden seçilmiş hız
- » Süper sessiz çalışma
- » Dahili ön filtrenin görünürlüğü, kolay erişim
- » Noryl® marka çok sağlam ve korozyona dayanıklı fan ve difüzör
- » Çift tahliye, kolay açılabilir kapak (alet gerektirmez)
- » Bağlantılar: ANSI 1½-2", Ø50 ve Ø63 mm yapıştırma rakorlar
- » 126 m³'e kadar olan havuzlarda kullanılır
- » Tuzlu suda kullanılabilir
- » Variable speed: high efficiency for each application, optimised consumption
- » 5 programs, 3 preselected speeds
- » Super-silent operation
- » Visibility of the internal prefilter, easy access
- » Impeller and diffuser made of Noryl very hard-wearing and corrosion-resistant
- » Double drain, easy opening (no tools required)
- » Connections: ANSI 1½-2", includes slip unions for Ø50 and Ø63 mm
- » Usage: for residential pools up to 126 m³
- » Suitable for use in salt water

50 ve 63 mm çapındaki rakor bağlantı parçaları sağlanır; mevcut herhangi bir kurulumla uyum sağlamak üzere tasarlanmıştır.

Union fittings provided, 50 and 63 mm diameter, to fit in any existing installation



Performans Eğrisi Performance Curves

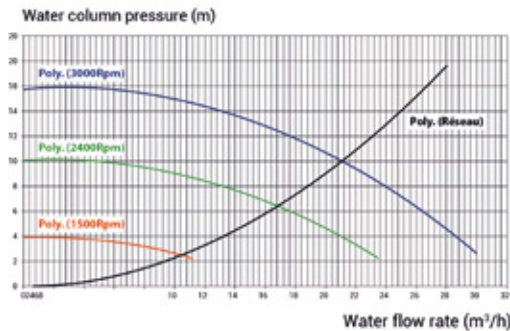

*10 mss basma yüksekliğinde 10 mss water column pressure

Ölçüler Dimensions

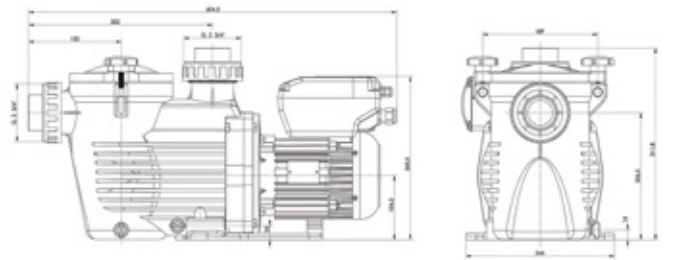

KOD CODE	MODEL MODEL	GÜÇ HP POWER HP	BAĞLANTI GİRİŞ ÇIKIŞ INLET OUTLET	DEBİ m³/h FLOW	GÜÇ KW POWER	SES ŞİDDETİ DP SOUND DP	AĞIRLIK Kg WEIGHT Kg	FİYAT PRICE
11515113151	KSE VS 150	1,5	Ø50 - Ø60	*21	1,24	-	15	1.800 €



Hayward Pompa Serisi *Hayward Pump Series*



Dünyaca Ünlü Hayward Artık Neta Havuz'da

Neredeyse bir asırlık tecrübeye sahip Hayward, havuz teknolojilerinde kalite ve güvenin simgesidir. Artık Neta Havuz güvencesiyle Türkiye'de, sessiz, verimli ve uzun ömürlü pompa çözümleriyle profesyonel ve özel projelerde fark yaratıyor.

The World-Renowned Hayward, Now at Neta Havuz

With nearly a century of expertise, Hayward stands for quality and reliability in pool technology. Now available in Turkey with Neta Havuz's assurance, Hayward offers quiet, efficient, and long-lasting pump solutions for both professional and residential pools.



HCP 3600

VERİMLİ PERFORMANS EFFICIENT PERFORMANCE

Büyük havuz, spa ve su oyunları için yüksek verimli ve kolay kurulabilen termoplastik pompa.
High-efficiency, easy-to-install thermoplastic pump for large pools, spas, and water features.

TİCARİ HAVUZ
COMMERCIAL POOL

DÜNYA MARKASI
GLOBAL BRAND

UZUN ÖMÜRLÜ
LONG LASTING

GÜÇLÜ & ÇOK YÖNLÜ
POWERFUL & VERSATILE

YÜKSEK VERİMLİ
HIGH EFFICIENCY

CE



MADE IN SPAIN



Öne Çıkan Özellikler Product Features

- » Cam elyaf takviyeli termoplastikten üretilmiş gövde
- » Hafif ve kolay monte edilebilir yapı
- » IE3 standartlarına uygun üç fazlı motor
- » Takviyeli Noryl malzemeden türbin
- » Tuzlu ve deniz suyunda kullanım imkânı
- » Kolay bakım için şeffaf kapaklı ön filtre
- » Twist-lock kapak, 75 mm çaplı rakor bağlantılarıyla birlikte
- » 50 Hz / 2.850 rpm, IP55, sınıf F izolasyonu
- » Talep üzerine ANSI bağlantı seçeneği

- » Housing made of glass-fibre reinforced thermoplastic
- » Lightweight and easy to install
- » Three-phase motor compliant with IE3 standard
- » Impeller made of reinforced Noryl
- » Suitable for salt water and sea water
- » Strainer with transparent cover for easy maintenance
- » Twist-lock cover includes 75 mm diameter socket unions
- » 50 Hz / 2,850 rpm, IP55, class F insulation
- » ANSI connection option available on request

Ölçüler Dimensions

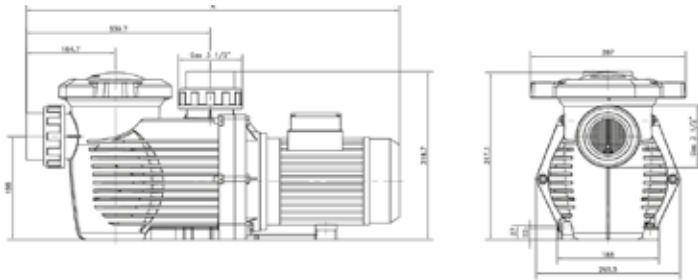

Performans Eğrisi Performance Curves

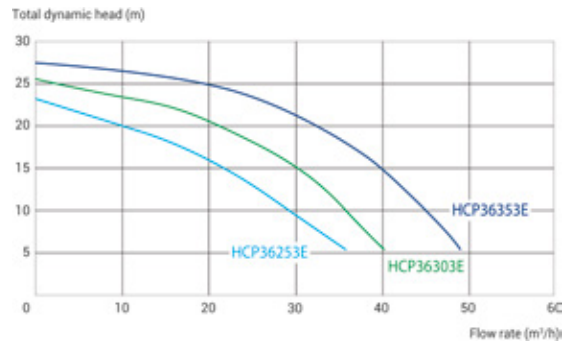

Teknik Bilgiler Technical Information

	MOTOR GÜCÜ TYPE HP	BOYUT A DIM A	AĞIRLIK WEIGHT	BAĞLANTI ÇAPI Ø FITTING Ø	DEBİ FLOW RATE	MAX GÜÇ TÜKETİMİ (W) P1 MAX (W) (Max consumption of the pump)	MAX AKIM (A) AMPS AT P1 MAX (A)
MONFAZE SINGLE PHASE	2,5	669 mm	27 kg	75 mm	40 m³/h	2200	10.7
	3	669 mm	27 kg	75 mm	43 m³/h	2600	12.6
TRİFAZE THREE PHASE	2,5	669 mm	28,5 kg	75 mm	30 m³/h	2400	8.3 / 4.8
	3	669 mm	28,5 kg	75 mm	36 m³/h	2800	8.8 / 5.1
	3,5	710 mm	31,5 kg	75 mm	45 m³/h	3800	12.1 / 7

*10 mss basma yüksekliğinde 10 mss water column pressure

Kullanım kılavuzuna ulaşmak için QR kodu okutun.

Scan the QR code to access the user manual.



KOD CODE	MODEL MODEL	GÜÇ HP POWER HP	BAĞLANTI GİRİŞ ÇIKIŞ INLET OUTLET	DEBİ m³/h FLOW	GÜÇ KW POWER	YETERLİLİK EFFICIENCY	AĞIRLIK Kg WEIGHT Kg	FİYAT PRICE
11515113161	HCP36251E	2,50 Tri	75 mm	*30	2,4	IE1	24	1.150 €
11515113158	HCP36301E	3,00 Tri	75 mm	*36	2,8	IE1	26	1.175 €
11515113157	HCP36353E	3,50 Tri	75 mm	*36	3,4	IE3	27	1.475 €

HCP 3800



INDUSTRIAL POWER ENDÜSTRİYEL GÜÇ

Büyük havuzlar, spa ve su oyunları için yüksek performanslı termoplastik pompa.
High-performance thermoplastic pump for large pools, spas, and water features.

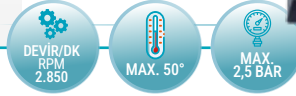

Öne Çıkan Özellikler Product Features

- » Hafif yapısı sayesinde kolay taşınır ve monte edilir.
- » Cam elyaf takviyeli termoplastikten üretilmiş gövde.
- » IE3 standartlarına uygun üç fazlı motor.
- » Takviyeli Noryl malzemeden üretilmiş türbin.
- » Tuzlu ve deniz suyunda kullanıma uygun.
- » Kolay bakım için şeffaf kapaklı ön filtre.
- » Motorun doğru havalandırması için yükseltilmiş taban.
- » 50 Hz / 2.850 rpm, IP55, sınıf F izolasyon.
- » Talep üzerine ANSI bağlantı seçeneği.

- » Lightweight for easy transport and installation
- » Housing made of glass-fibre reinforced thermoplastic
- » Three-phase motor compliant with IE3 standard
- » Impeller made of reinforced Noryl
- » Suitable for salt water and sea water
- » Strainer with transparent lid for easy maintenance
- » Elevated base for proper motor ventilation
- » 50 Hz / 2,850 rpm, IP55, class F insulation
- » ANSI connection option available on request

Ölçüler Dimensions

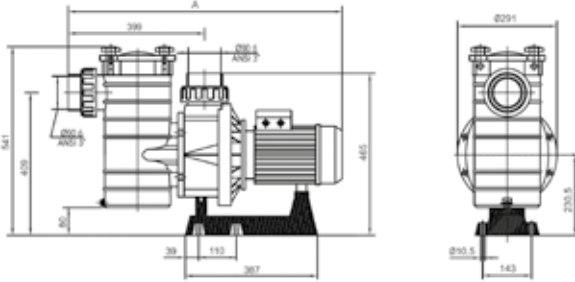

Performans Eğrisi Performance Curves

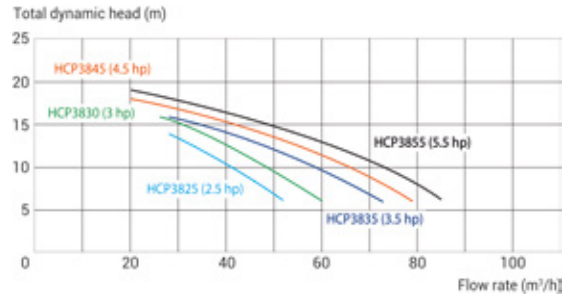

Teknik Bilgiler Technical Information

REFERANS REFERENCE	GÜÇ HP P2 HP	GÜÇ KW P1 KW	DEBİ FLOW RATE	GİRİŞ-ÇIKIŞ INLET OUTLET	MOTOR MOTOR	AKIM (A) AMPERAGE	BOYUT (A) DIM (A)	PAKET ÖLÇÜ PACKAGING DIM	PALET BAŞI- NA ADET QTY. PER PALLET (UDS)
HCP38553E1	5.5	4.7	67 m³/h	90 mm	Three-phase 230 / 400 V	14.6 / 8.5	815 mm	830 x 330 x 570	12

*12 m su kolon basıncı altında / P1: Giriş Gücü / P2: Nominal Güç
Temmuz 2023 itibarıyla monofaze pompalar için IE2 motorlu yeni modeller mevcut olacaktır.

* under 12 m water column pressure / P1: Power input / P2: Nominal Power
New references with IE2 motor will be available from July 2023 for single-phase pumps.

Kullanım kılavuzuna ulaşmak için QR kodu okutun.



Scan the QR code to access the user manual.

KOD CODE	MODEL MODEL	GÜÇ HP POWER HP	BAĞLANTI GİRİŞ ÇIKIŞ INLET OUTLET	DEBİ m³/h FLOW	GÜÇ KW POWER	YETERLİLİK EFFICIENCY	AĞIRLIK Kg WEIGHT Kg	FİYAT PRICE
11515113131	HCP3855	5,50 Tri	90 mm	*67	4,7	IE1	35,5	1.750 €

HCP 4000

YÜKSEK KAPASİTE HIGH CAPACITY

Çok büyük havuzlar, spa ve su göstere-
rileri için tasarlanmış yüksek kapasite-
li termoplastik pompa.

High-capacity thermoplastic pump
designed for very large pools, spas, and
water features.



TİCARİ HAVUZ
COMMERCIAL POOL

DÜNYA MARKASI
GLOBAL BRAND

YÜKSEK VERİMLİ
HIGH EFFICIENCY

UZUN ÖMÜRLÜ
LONG LASTING

CE



MADE IN
SPAIN



Öne Çıkan Özellikler Product Features

- » Kendinden emişli santrifüj pompa, cam elyaf takviyeli termoplastik gövde
- » Hafif yapısı sayesinde kolay taşınır ve monte edilir
- » IE3 standartlarına uygun üç fazlı motor
- » Yüksek performanslı hidrolik sistem
- » Takviyeli Noryl malzemeden üretilmiş türbin
- » Tuzlu ve deniz suyunda kullanıma uygun
- » Yüksek performanslı TEFC motor
- » Kolay bakım için 14 litrelik şeffaf kapaklı ön filtre
- » Motorun doğru havalandırması için yükseltilmiş taban
- » 50 Hz / 2.850 rpm, IP55, sınıf F izolasyon
- » Talep üzerine ANSI bağlantı seçeneği

- » Self-priming centrifugal pump with glass-fibre reinforced thermoplastic housing
- » Lightweight for easy transport and installation
- » Three-phase motor compliant with IE3 standard
- » High-performance hydraulics
- » Impeller made of reinforced Noryl
- » Suitable for salt water and sea water
- » High-performance TEFC motor
- » 14 L transparent cover strainer for easy maintenance
- » Elevated base for proper motor ventilation
- » 50 Hz / 2,850 rpm, IP55, class F insulation
- » ANSI connection option available on request

Kullanım kılavuzuna ulaşmak için QR kodu okutun.

Scan the QR code to access the user manual.



Ölçüler Dimensions

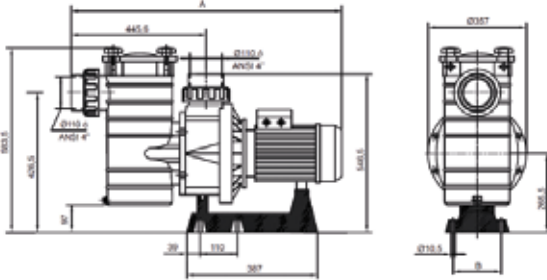

Performans Eğrisi Performance Curves

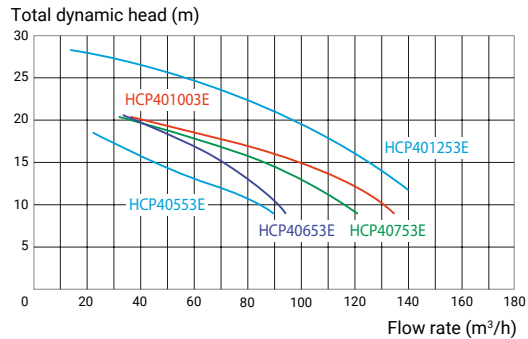

Teknik Bilgiler Technical Information

REFERANS REFERENCE	GÜÇ HP P2 HP	GÜÇ KW P1 KW	DEBİ FLOW RATE	GİRİŞ-ÇIKIŞ INLET OUTLET	MOTOR MOTOR	AKIM (A) AMPERAGE	BOYUT (A) DIM (A)	PAKET ÖLÇÜ PACKAGING DIM	PALET BAŞI- NA ADET QTY. PER PALLET (UDS)
HCP401253E	12.5	10.2	124 m³/h	110 mm	Three-phase 400 / 700 V	18,0 / 10,4	984 mm	940 x 390 x 620	3

KOD CODE	MODEL MODEL	GÜÇ HP POWER HP	BAĞLANTI GİRİŞ ÇIKIŞ INLET OUTLET	DEBİ m³/h FLOW	GÜÇ KW POWER	YETERLİLİK EFFICIENCY	AĞIRLIK Kg WEIGHT Kg	FİYAT PRICE
11515113113	HCP401253E	12.50 Tri	110 mm	*137	10,2	IE3	76	3.850 €

HCP 4200



DENGELİ PERFORMANS BALANCED PERFORMANCE

1.450 rpm motoru ve takviyeli yapısıyla yüksek performans, düşük gürültü.

With its 1,450 rpm motor and reinforced design, it delivers high performance with low noise.



TİCARİ HAVUZ
COMMERCIAL POOL

DÜNYA MARKASI
GLOBAL BRAND

YÜKSEK VERİMLİ
HIGH EFFICIENCY

UZUN ÖMÜRLÜ
LONG LASTING



Öne Çıkan Özellikler Product Features

- » Cam elyaf takviyeli termoplastikten üretilmiş gövde
- » IE3 standartlarına uygun üç fazlı motor
- » Takviyeli Noryl malzemeden türbin
- » 4 kutuplu motor (1.450 rpm / 50 Hz)
- » Tuzlu ve deniz suyu kullanılabılır
- » 14 litrelik yüksek kapasiteli, şeffaf kapaklı ön filtre
- » Yükseltilmiş taban, motor havalandırmasını optimize eder
- » Talep üzerine ANSI bağlantı seçeneği

- » Housing made of glass-fibre reinforced thermoplastic
- » Three-phase motor compliant with IE3 standard
- » Impeller made of reinforced Noryl
- » 4-pole motor operating at 1,450 rpm / 50 Hz
- » Suitable for salt and sea water
- » 14 L transparent strainer cover for easy maintenance
- » Elevated base ensures optimal motor ventilation
- » ANSI connection option available on request

Ölçüler Dimensions

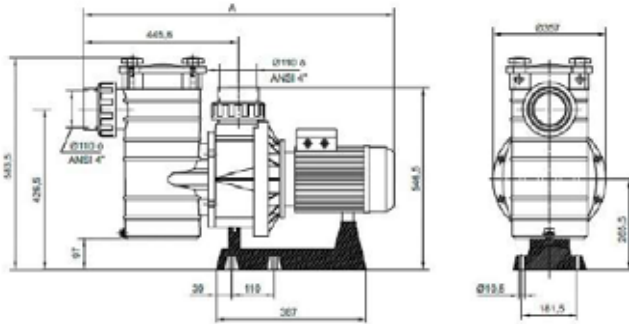

Performans Eğrisi Performance Curves

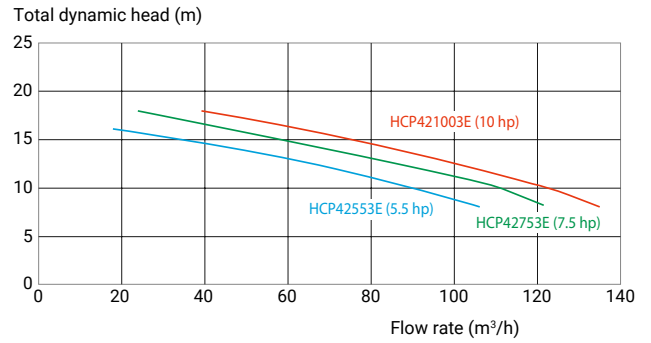

KOD CODE	MODEL MODEL	GÜÇ HP POWER HP	BAĞLANTI GİRİŞ ÇIKIŞ INLET OUTLET	DEBİ m³/h FLOW	GÜÇ KW POWER	YETERLİLİK EFFICIENCY	AĞIRLIK Kg WEIGHT Kg	FİYAT PRICE
11515113175	HCP42553E	5.50	110 mm	*68	4.71	IE3	46	--
11515113176	HCP42753E	7.50	110 mm	*90	7.00	IE3	50	--
11515113177	HCP421003E	10.00	110 mm	*104	8.70	IE3	70	--

HAYWARD & KRIPSOL MOTORLARI YENİ DÜZENLEME ENERJİ VERİMLİLİĞİ STANDARTLARI

(EU) 2019/1781 Komisyon Düzenlemesi

HAYWARD & KRIPSOL PUMPS ENERGY EFFICIENCY STANDARDS

Commission Regulation (EU) 2019/1781

Yürürlüğe Giriş Tarihleri

1 Temmuz 2021 itibariyle

- Nominal gücü 0,75 kW (1 HP) ve 1000 kW (1341 HP) arasında olan, 2 veya 4 kutuplu üç fazlı motorlar en az IE3 verimlilik seviyesinde olmalıdır.
- Nominal gücü 0,12 kW (0,16 HP) ile 0,75 kW (1 HP) arasında olan üç fazlı motorlar en az IE2 verimlilik seviyesinde olmalıdır.

1 Temmuz 2023 itibariyle

- 0,12 kW (0,16 HP) ve üzeri nominal güce sahip monofaze motorlar IE2 verimlilik sınıfına geçmiştir.

Effective Dates

From 1st July 2021

- Three-phase motors with a rated output between 0.75 kW (1 HP) and 1000 kW (1341 HP), with 2 or 4 poles, must meet at least the IE3 efficiency level.
- Three-phase motors with a rated output between 0.12 kW (0.16 HP) and 0.75 kW (1 HP) must meet at least the IE2 efficiency level.

From 1st July 2023

- Single-phase motors with a rated output equal to or above 0.12 kW (0.16 HP) are now upgraded to the IE2 efficiency class in compliance with the new directive.

KUTUPLAR POLES

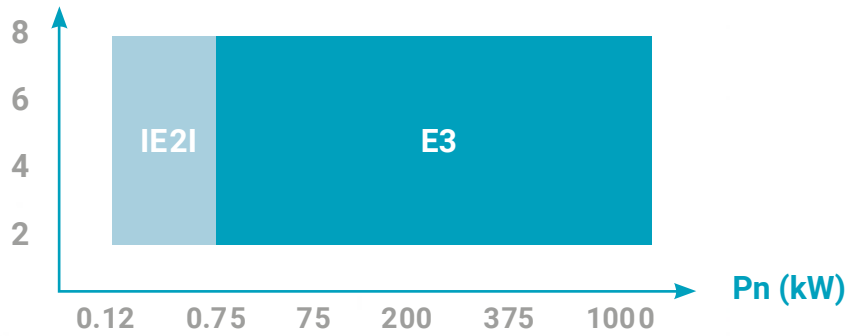

Tablo2 Table 2

Yeni düzenleme Hayward ve Kripsol motorlarını nasıl etkiler?

How Does the New Regulation Affect Hayward and Kripsol Pumps?

Hayward®, tüm ürünlerini Avrupa Parlamentosu ve Konseyi tarafından belirlenen enerji verimliliği standartlarına uygun olarak tasarlamakta ve üretmektedir.

Yeni yönetmeliklere uygun olarak, tüm Hayward® pompaları IE2 veya IE3 motor verimlilik sınıfları ile sunulacaktır.

Hayward and Kripsol designs and manufactures all pool equipment in compliance with EU energy efficiency standards. As part of ongoing product development, Hayward® pumps are now offered with IE2 or IE3 energy-rated motors, ensuring higher performance and sustainability.

Kontrol Panoları

Control Panels

Lüks Seri

Lux Series

Öne Çıkan Özellikler

Product Features

Kaçak akım rölesi ve motor faz koruması tüm panolarda fiyatlara dahildir
Leakage current relay and motor phase protection are included in all panels



KOD CODE	AÇIKLAMA DESCRIPTION	FİYAT PRICE
15015122029	1 Pompa+1 Grup Lamba Monofaze 1 Pump+1 Group Lamp Single Phase	270 €
15015122030	1 Pompa+1 Grup Lamba Trifaze 1 Pump+1 Group Lamp Three Phase	360 €
15015122031	2 Pompa+2 Grup Lamba Monofaze 2 Pump+2 Group Lamp Single Phase	408 €
15015122032	2 Pompa+2 Grup Lamba Trifaze 2 Pump+2 Group Lamp Three Phase	534 €
15015122027	3 Pompa+1 Grup Lamba Monofaze 3 Pump+1 Group Lamp Single Phase	576 €
15015122028	3 Pompa+1 Grup Lamba Trifaze 3 Pump+1 Group Lamp Three Phase	702 €

Zaman Röleli

With Timer

Öne Çıkan Özellikler

Product Features

- » Korozyona karşı dayanıklı gövde
- » CE belgeli şalt malzemesi
- » 1 pompa, 1 grup lamba; 1 adet 3 HP'ye kadar pompa ve 1 grup 300 Watt'a kadar lambayı kontrol eder
- » 2 pompa, 2 grup lamba; 2 adet 3 HP'ye kadar pompa ve 2 grup 300 Watt'a kadar lambayı kontrol eder
- » Corrosion resistant housing
- » CE certified circuit
- » 1 pcs pump, 1 group lamp controls up to 1 pcs 3 HP pump and 1 group 300 Watt lamp
- » 2 pcs pump, 2group lamp controls up to 2 pcs 3 HP pump and 2 group 300 Watt lamp



KOD CODE	AÇIKLAMA DESCRIPTION	FİYAT PRICE
15015122033	1 Pompa+1 Grup Lamba Monofaze 1 Pump+1 Group Lamp Single Phase	330 €
15015122034	1 Pompa+1 Grup Lamba Trifaze 1 Pump+1 Group Lamp Three Phase	420 €
15015122035	2 Pompa+2 Grup Lamba Monofaze 2 Pump+2 Group Lamp Single Phase	488 €
15015122036	2 Pompa+2 Grup Lamba Trifaze 2 Pump+2 Group Lamp Three Phase	594 €
15015122046	3 Pompa+3 Grup Lamba Monofaze 3 Pump+3 Group Lamp Single Phase	636 €
15015122047	3 Pompa+3 Grup Lamba Trifaze 3 Pump+3 Group Lamp Three Phase	762 €

Senkron Smart Dalgıç Pompa

Senkron Smart Submersible Pump

Öne Çıkan Özellikler Product Features

- » Aşırı ısınma koruma rölesi ile güvenli ve güvenilir çalışma
- » Gizli flatör
- » 10 m³/h debi
- » Bakır sargı elektrik motoru
- » Kirden sıkışmayan flatör sistemi
- » Tek kademeli
- » Safe and reliable operation with overheat protection relay
- » Hidden floater
- » Flow rate of 10 m³/h
- » Copper wounded electric motor
- » Floater system not jammed from dirt
- » Single stage

Kullanım kılavuzuna ulaşmak için QR kodu okutun.

Scan the QR code to access the user manual.



KOD CODE	AÇIKLAMA DESCRIPTION	GÜÇ POWER	DEBİ L/H FLOW L/H	BASMA YÜKSEKLİĞİ HEAD	KABLO CABLE	VOLTAJ VOLTAGE	FİYAT PRICE
19810123080	Dalgıç Pompa Submersible Pump	550W	10.000	8,5 mt	10 mt	220V/50Hz	110 €
11516262039	Havuz Örtüsü Dalgıç Pompası Submersible Pump for Pool Cover	0,55 kW	10.000	8,5 mt	10 mt	220V/50Hz	150 €

Trione Dalgıç Pompa

Trione Submersible Pump

Öne Çıkan Özellikler Product Features

- » Aşırı ısınma koruma rölesi ile güvenli ve güvenilir çalışma
- » Gizli flatör
- » 10 m³/h debi
- » Alüminyum sargı elektrik motoru ve dolayısıyla piyasanın en uygun fiyatlı dalgıç pompası
- » Tek kademeli
- » Safe and reliable operation with overheat protection relay
- » Hidden floater
- » Flow rate of 10 m³/h
- » Aluminum wounded Electric motor with the most affordable submersible pump on the market
- » Single stage

Kullanım kılavuzuna ulaşmak için QR kodu okutun.

Scan the QR code to access the user manual.



KOD CODE	AÇIKLAMA DESCRIPTION	GÜÇ POWER	DEBİ L/H FLOW L/H	BASMA YÜKSEKLİĞİ HEAD	KABLO CABLE	VOLTAJ VOLTAGE	FİYAT PRICE
19810123081	Dalgıç Pompa Submersible Pump	550W	10.000	8 mt	10 mt	220V/50Hz	90 €