





02

YÜZME HAVUZU FİLTRELERİ SWIMMING POOL FILTERS

25-52



Neta Havuz Üretimi
Manufactured By Neta Pool



Özel Amaçlı Havuz
Residential Pool



Türkiye'de Üretilmiştir
Made In Turkey



Plastik Şişme
Blowmolding Body



MAX.
35°C



TEST
3,0 BAR



MAX.
2,0 BAR

- Ø300mm siyah takviyeli kapak, filtre kapağı giriş çapı Ø220
- Korozyona dayanıklı hava tahliye tapası ile birlikte
- Krom kaplama dişli, renk işaretli manometresi
- 1" geniş kum tahliyesi
- MIDAS Almanya ve Peraqua Avusturya menşei yandan çok yönlü vanası dahildir
- Filtre tankında 3 yıl garanti

- Black reinforced lid of Ø300mm, filter lid access dia Ø220
- Supplied with robust manometer & air release tee
- Supplied with color marked manometer with a chrome plated thread
- Large sand drain of 1"
- Supplied with side valve Midas Germany and Peraqua Austria
- Warranty of 3 years on filter tank



KULLANIM KILAVUZU

KOD CODE	ÇAP DIAMETER	BAĞLANTI GİRİŞ ÇIKIŞ INLET OUTLET	DEBİ m³/h FLOW	KUM Kg SAND Kg	AĞIRLIK Kg WEIGHT Kg	
12015123200	500 mm	1 ½	10	100	13	
12015123201	620 mm	1 ½	14	175	16,5	
12015123202	760 mm	2"	22	300	21	

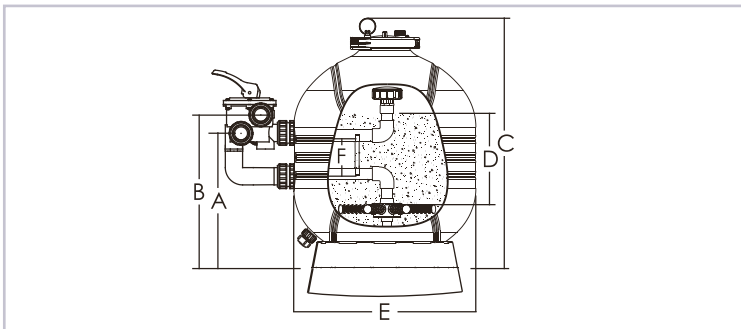

MODEL	A mm	B mm	C mm	D mm	E mm	F mm
500 »	465	530	800	340	500	70
620 »	525	590	900	340	620	100
760 »	580	650	1040	400	760	100



Neta Havuz Üretimi
Manufactured By Neta Pool



Özel Amaçlı Havuz
Residential Pool



Türkiye'de Üretilmiştir
Made In Turkey



Polyester Kaplamalı
Polyester Laminated



2+2 Yıl Garantili
2+2 Year Warranty



MAX.
40°C



TEST
2,5 BAR



MAX.
2,0 BAR

- Özel amaçlı havuz kullanımı içindir
- İsteğe bağlı olarak farklı renklerde üretilebilir
- İsteğe bağlı olarak şeffaf kapak ile verilebilir
- İthal Midas (Almanya) veya Praher (Avusturya) çok yollu yandan vana veya yerli üretim vana seçeneği ile
- Isıtmalı havuzlarda kullanıma uygundur
- UV dayanımlıdır, açık ortamda montaj edilebilir

- Suitable for residential pool
- Optionally as it can be produced in different colors
- Optionally as it can be produced in transparent lid upon request
- Side mounted multiport valves made in Türkiye or Midas (Germany), Praher (Austria)
- Can be used for heated pools
- Can be installed outdoors



KOD	ÇAP	BAĞLANTI GİRİŞ ÇIKIŞ	DEBİ m ³ /h	KUM Kg	AĞIRLIK Kg	
CODE	DIAMETER	INLET OUTLET	FLOW	SAND Kg	WEIGHT Kg	
12015122046	500 mm	1 ½"	8	75	18	315 €
12015122021	650 mm	1 ½"	15	150	19	355 €
12015122077	720 mm	1 ½"	22	300	27	450 €
12015122078	720 mm	2"	22	300	27	480 €
12015122022	800 mm	2"	22	350	30	508 €
12015122037	900 mm	2"	30	400	37	545 €
YERLİ VANALI YENİ FİYAT, İYİ FİYAT GOOD PRICE WITH MULTIPORT VALVE MADE IN TURKEY						
12015122079	500 mm	1 ½"	8	75	18	290 €
12015122080	650 mm	1 ½"	15	150	19	330 €
12015122081	720 mm	1 ½"	22	300	27	410 €
12015122082	720 mm	2"	22	300	27	440 €
12015122083	800 mm	2"	22	350	30	468 €
12015122084	900 mm	2"	30	400	37	505 €

Ozona dayanıklı hammaddelerle üretim yapılması durumunda % 30 fiyat farkı uygulanmaktadır.
In case of production with ozone-resistant raw material, additional 30% price increase is applied.

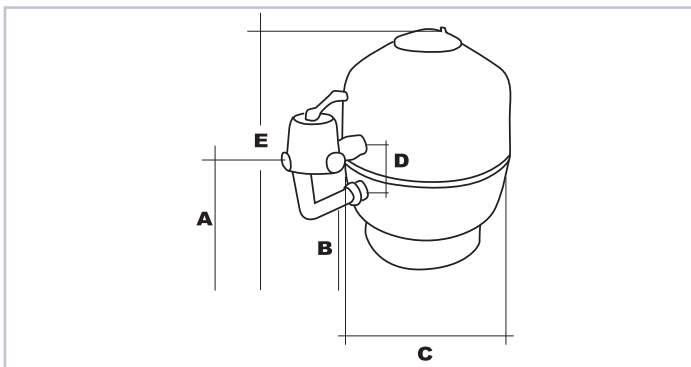

MODEL	A mm	B mm	C mm	D mm	E mm
LS 500 »	335	270	500	135	770
LS 650 »	380	320	650	140	800
LS 720 »	390	320	750	150	850
LS 800 »	400	325	800	160	900
LS 900 »	460	370	950	240	1.050



Neta Havuz Üretimi
Manufactured By Neta Pool



Ticari Havuz
Commercial Pool



Türkiye'de Üretilmiştir
Made In Turkey



Polyester Kaplamalı
Polyester Laminated



2+2 Yıl Garantili
2+2 Year Warranty



50 cm Çapında Plastik Kapak
Diameter With 50 cm Plastic Lid



MAX.
40C°



TEST
2,5 BAR



MAX.
2,0 BAR



MAX.
50 m³/h/m²

- Ticari havuzlar, su parkları, fiskiyeler için uygundur
- İsteğe bağlı olarak farklı renklerde üretilebilir
- Ø50 cm cam elyaf takviyeli plastik kapak
- Isıtmalı havuzlarda kullanıma uygundur
- UV dayanımlıdır
- Açık ortamda montaj edilebilir
- Aşındırıcı olmayan polyester, pürüzsüz çekici kaplamaya sahip fiberglas kompozit yapı
- 6 yollu vana dahil değildir

- Suitable for commercial pools, waterparks, fountains etc.
- Optionally as it can be produced in different colors
- Ø50 cm diameter plastic lid from fibre glass reinforced
- Can be used for heated pools
- UV resistant
- Can be installed outdoors
- Non-Corrosive polyester, fiberglass composite construction with smooth attractive finish
- Excluded in 6-way valve



KOD CODE	ÇAP DIAMETER	BAĞLANTI GİRİŞ ÇIKIŞ INLET OUTLET	DEBİ m³/h FLOW	KUM Kg SAND Kg	AĞIRLIK Kg WEIGHT Kg	
12015122056	1.050 mm	75	43	1.050	95	847 €
12015122057	1.250 mm	90	56	1.200	110	1.089 €
12015122063	1.400 mm	110	77	1.950	160	1.573 €
12015122058	1.600 mm	110	100	3.050	175	1.936 €
12015122059	2.000 mm	160	157	4.950	224	3.135 €
12015122065	2.200 mm	--	--	--	--	5.747 €

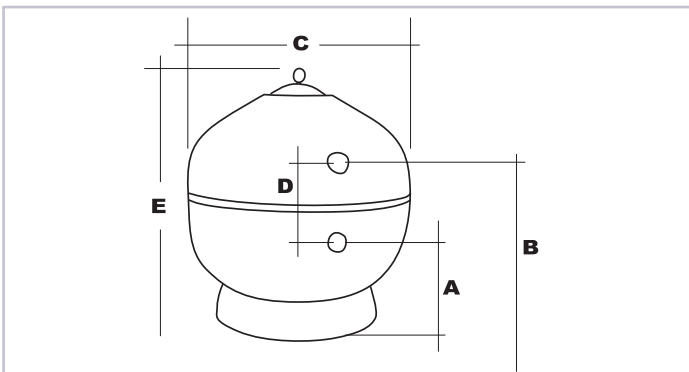

MODEL	A mm	B mm	C mm	D mm	E mm
LS 1.050 »	670	440	1.050	460	1.380
LS 1.250 »	570	360	1.250	460	1.350
LS 1.450 »	800	630	1.400	440	1.630
LS 1.600 »	850	690	1.600	450	1.750
LS 2.000 »	900	785	2.000	490	1.850

Ozona dayanıklı hammadde ile üretim yapılması durumunda % 30 fiyat farkı uygulanmaktadır.
In case of production with ozone-resistant raw material, additional 30% price increase is applied.

ROTEX PLASTİK FİLTRE

ROTEX POLYETHYLEN FILTER



Neta Havuz Üretimi
Manufactured By Neta Pool



Polietilen Rotasyon Gövde
Rotomolding PE Body



2+2 Yıl Garantili
2+2 Year Warranty



MAX.
28C°



MAX.
2,5 BAR



MAX.
50 m³/h/m²



- Alman menşeli altı yollu vana ile birlikte teslim edilir
- Isıtılmı havuzlar için uygun deęildir MAX. 28C°
- Plastik gövdeli olduęu için dıř ortamda kullanımı tavsiye edilmez
- Supplied with side multiport valve made by Midas (Germany)
- It is not suitable to use for heated pools. Max. operating temperature is 28 °C
- It is not suitable for outdoor installation



KOD CODE	ÇAP DIAMETER	BAĞLANTI GİRİŞ ÇIKIŞ INLET OUTLET	DEBİ m³/h FLOW	KUM Kg SAND Kg	AĞIRLIK Kg WEIGHT Kg	
12015122048	500 mm	50	8	75	-	247 €
12015122053	600 mm	50	12	150	-	278 €

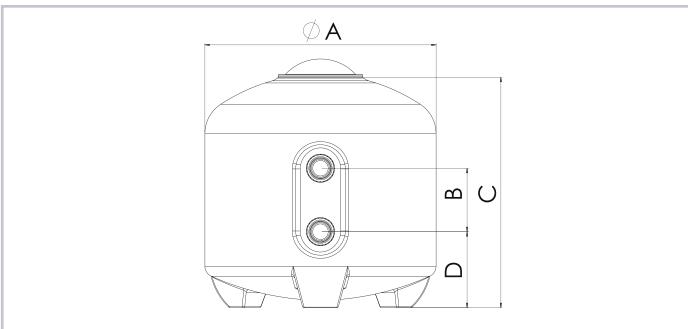

MODEL	A mm	B mm	C mm	D mm
ROTEX 500 »	500	125	610	210
ROTEX 600 »	600	125	635	240



2+2 Yıl Garantili
2+2 Year Warranty



MAX.
40°C



MAX.
2,5 BAR



TEST
2,5 BAR



MAX.
50 m³/h/m²

**NEW
PRODUCT**

- Sağlam, UV ışınlarına dayanıklı polyester bobin sargı gövde
- Ergonomik dizayn edilmiş altı yollu vana
- Yüksek performanslı filtrasyon işlemi
- Her çeşit havuza, tatlı veya tuzlu suya uygundur
- İşletme basıncını kontrol etmek için manometre
- Filtrelenmiş suyu gözlemlmek için gözetleme camı
- Kilitli kelepçe, vananın 360° boyunca istenilen pozisyonda montaj yapılmasını sağlar
- Suyun kum yatağının üzerine düzenli olarak dağılmasını sağlayan üst difüzör
- Ani kış etkileri ve bakım için basınçla su ve kum tahliye çıkışı
- 7 yollu vana ile birlikte

- Heavy duty UV protected polyester bobbin wounded tank
- Ergonomically designed six position multiport valve
- High performance filtering action
- Suitable for all pools types, fresh or salt water
- Special glycerine stainless construction pressure gauge for operating pressure
- Sight glass for inspection of the filtered water
- Clamp lock is designed to allow 360 degree rotation to simplify installation
- Top diffuser ensures even distribution of water over the sand bed
- A plug to drain out for sand and water drain with pressure
- Included in 7-way valve

**STOK
ÜRÜNÜ!**

**READY
STOCK!**



KOD CODE	ÇAP DIAMETER	BAĞLANTI GİRİŞ ÇIKIŞ INLET OUTLET	DEBİ m ³ /h FLOW	KUM Kg SAND Kg	AĞIRLIK Kg WEIGHT Kg	
12015123100	525 mm	50 mm	12	85	14.4	285 €
12015123101	625 mm	50 mm	16	150	18	350 €
12015123102	750 mm	63 mm	23	300	34	510 €
12015123103	900 mm	63 mm	31	470	59	630 €

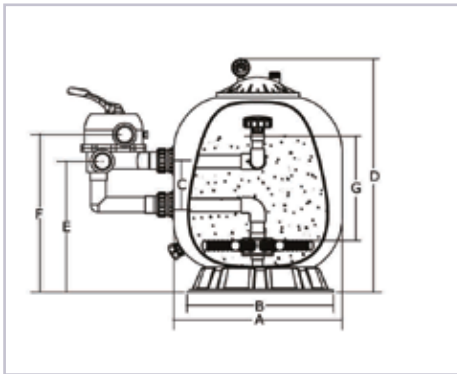

MODEL	A mm	B mm	C mm	D mm	E mm	F mm	G mm	Hacim Volume
525 »	780	525	220	650	370	400	320	0.22 m ³
625 »	880	625	220	800	420	450	350	0.30 m ³
750 »	960	750	220	900	550	600	400	0.45 m ³
900 »	1100	900	220	1100	640	700	500	0.64 m ³

BS MODEL BOBBIN WOUND FILTERS



Bobin Sargı
Bobbin Wound



Dayanıklı Yapı
Resistant Body



MAX.
40C°



MAX.
2,5 BAR



TEST
3,5-3,75 BAR



MAX.
50 m³/h/m²

- 460 mm'lik filtreye kadar altı yollu yandan vanası ile birlikte sevk edilir
- Yüksek UV ışınlarına dayanıklı polyester bobin sargılı gövde
- Suyun kum yatağına eşit dağılımını sağlayan üst difüzör
- Isıtmalı havuzlar için uygundur
- Her tür havuz suyuna tatlı veya tuzlu suya uygundur
- Çalışma basıncını gözlemek için gliserinli manometre
- Filtrelenmiş suyu gözlemek için gözetleme camı
- Üstten vanalı modellerde döner kelepçe, her pozisyonda kolay montaj yapmayı sağlar
- Difüzör, suyun kum yatağına eşit dağılımını sağlar
- Ani kış koşulları ve bakım için yüksek basınç ile su ve kum takviyesi

- Includes in side mounted multiport valve up to 460 mm filter
- High UV Resistance polyester bobin wound body
- Top diffuser that ensures the distribution of water equally to the sand bed
- Can be used for heated pools
- Suitable for all pools types, fresh or salt water
- Special glycerine stainless construction pressure gauge for operating pressure
- Sight glass for inspection of the filtered water
- Clamb lock is designed to allow 360 degree rotation to simplift
- Top diffuser ensures even distribution of water over the sand bed
- Large pressure sand/water drain for rapid winterezing or servicing



KOD CODE	ÇAP DIAMETER	MODEL MODEL	BAĞLANTI GİRİŞ ÇIKIŞ INLET OUTLET	DEBİ m³/h FLOW	KUM Kg SAND Kg	AĞIRLIK Kg WEIGHT Kg	
12015123062	460 mm	BS 460	50 mm	8	75	16	340 €

FİBERGLASS TAKVİYELİ POLYESTER FİLTRE FIBERGLASS REINFORCED POLYESTER FILTERS

TASARRUFTA LİDER!

Çok çeşitli medya filtreleri vardır. En yaygın olanları kum, kırma cam veya diatomlu toprak yatakları kullananlardır. Ancak son birkaç yılda, daha büyük su hacimlerini küçük bir filtreyle filtrelemedeki mükemmel sonuçları sayesinde rejeneratif ortam filtresi giderek daha popüler hale geliyor. Sonuç, aynı çapta, rejeneratif ortam filtresinin işleyebileceği su hacminin önemli ölçüde daha yüksek olmasıdır.

Bu filtreler mükemmel kalitede bir filtreleme sağlar ve aynı zamanda geleneksel yöntemlere kıyasla su ve enerji maliyetlerini önemli ölçüde azaltır.

LEADER IN SAVINGS!

There is a wide range of media filters. The most common are the ones using beds of sand, crushed glass or diatomaceous earth. But in the last few years the regenerative media filters are getting more and more popular thanks to its excellent results in filtering bigger water volumes with a small filter. The result is that, in the same diameter, the volume of water that the regenerative media filter can process is considerably higher.

These filters deliver an excellent quality filtering and, at the same time, reduce significantly the water and energy costs, compared to traditional methods



Bir mikrondan büyük partikülleri filtreler.
Filtering particles larger than one micron

ÇAP DIAMETER	MODEL	BAĞLANTI GİRİŞ ÇIKIŞ IN OUT PIPES	DEBİ m ³ /h FLOW	PERLİT Kg PERLITE Kg	YÜKSEKLİK HEIGHT	FİLTRE ALANI FILTER AREA
620 mm	RF-PRFV-620	D125 - DN110	36-64	7	1.850 mm	14,2 m ²
750 mm	RF-PRFV-750	D140 - DN125	54-98	11	1.900 mm	21,8 m ²
900 mm	RF-PRFV-900	D160 - DN150	79-142	16	1.950 mm	31,6 m ²
1.050 mm	RF-PRFV-1050	DN200	125-225	24	2.050 mm	50,1 m ²
1.200 mm	RF-PRFV-1200	DN250	162-292	34	2.100 mm	64,8 m ²
1.400 mm	RF-PRFV-1400	D315 - DN300	227-408	44	2.200 mm	90,7 m ²
1.600 mm	RF-PRFV-1600	D315 - DN300	286-514	58	2.200 mm	114,3 m ²

Debi oranı 2.5 ve 4.5 m³/h/m² filtre oranında Flow rates at 2.5 and 4.5 m³/h/m² filter rates

PASLANMAZ ÇELİK AISI 304L & 316L FİLTRE STAINLESS STEEL AISI 304L & 316L FILTERS

HAVUZLAR, SPALAR, SU PARKLARI, DOĞAL GÖLETLER ENDÜSTRİYEL İŞLER

Patentli bir teknolojiye dayanan REGFILTER, kum veya cam filtreler gibi daha geleneksel teknolojilere kıyasla filtreleri için daha iyi bir performans ile daha uzun bir ömür beklentisi ve maksimum su, enerji ve kimyasal tasarrufu elde etti.

Rejeneratif ortam filtreleri REGFILTER, aynı zamanda bakım maliyetlerinden tasarruf sağlayan ve mobil parçalar ve titreşimler olmaksızın, karmaşık temizleme işlemlerine gerek olmadan, patentli bir "kendi kendini temizleme" sistemine sahiptir.

POOLS, SPAS, WATER PARKS ARTIFICIAL LAKES INDUSTRIAL PROCESSES

Regfilter, based on a patented technology, has achieved a better performance and a longer life expectancy for its filters and a maximum water, energy and chemical savings, compared to more conventional technologies, such as sand or glass filters.

The regenerative media filters Regfilter includes a patented self-cleaning system that also allows maintenance cost savings and make complicated cleaning operations not necessary, without mobile parts or vibrations.

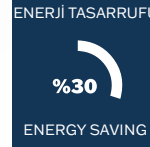
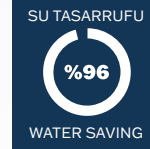

Bir mikrondan büyük partikülleri filtreler.
Filtering particles larger than one micron

ÇAP DIAMETER	MODEL MODEL	BAĞLANTI GİRİŞ ÇIKIŞ IN OUT PIPES	DEBİ m³/h FLOW	PERLİT Kg PERLITE Kg	YÜKSEKLİK HEIGHT	FİLTRE ALANI FILTER AREA
400 mm	RF-3xxL-400	DN 65	15-27	3	1.800 mm	6,0 m²
600 mm	RF-3xxL-600	DN 125	40-71	8	1.900 mm	15,8 m²
800 mm	RF-3xxL-800	DN 150	77-139	16	1.950 mm	30,9 m²
1.000 mm	RF-3xxL-1000	DN 200	130-234	25	2.050 mm	52,0 m²
1.200 mm	RF-3xxL-1200	DN 250	170-307	36	2.100 mm	68,2 m²
1.400 mm	RF-3xxL-1400	DN 250	232-418	45	2.100 mm	93,0 m²
1.600 mm	RF-3xxL-1600	DN 300	300-540	60	2.200 mm	120,0 m²

* Debi oranı 2.5 ve 4.5 m³/h/m² filtre oranında Flow rates at 2.5 and 4.5 m³/h/m² filter rates

TÜRKİYE'DE BİR İLK! DIŞ MEKANDA DA KULLANILAN FİLTASYON SİSTEMİ

- Dünya markası Bestway'den 60 m³'e kadar olan havuzlar için mükemmel filtrasyon sağlar
- Kolay bakım
- Basit montaj
- Dış mekanda kullanıma uygun filtrasyon sistemi (yağmur, kar etkilemez)
- Makina dairesi ve elektrik panosu gerektirmez
- Pompa üzerinde timer (zaman saati) ve ON/OFF düğmesi
- Altı yollu vanası ile birlikte
- Monofaze
- Difüzör, suyun kum yatağına eşit dağılımını sağlar

KULLANIM ALANLARI

- 60 tona kadar yüzme havuzları
- Çocuk havuzları
- Süs havuzları
- Sulama havuzları
- Peyzaj sprinkler depoları
- Jakuziler
- Balık havuzları
- Doğal havuzlar
- Su arıtma ön filtrasyonu
- Kaskad şelaleler

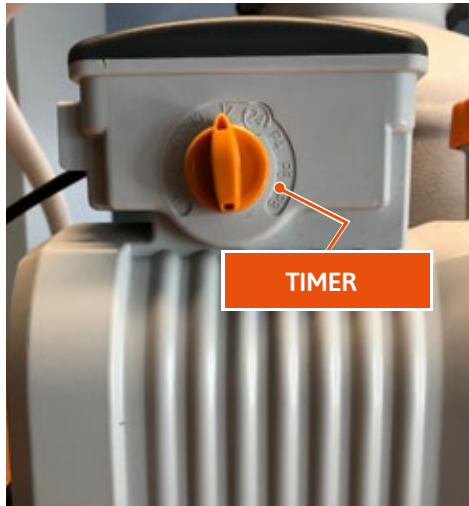

THE FIRST IN TURKEY! FILTRATION SYSTEM, ALSO USED IN OUTDOOR !

- Provides perfect filtration for pools up to 60 m³ from the world brand Bestway
- Easy maintenance
- Simple installation
- Filtration system suitable for outdoor use (rain, snow does not affect)
- Does not require technical room and electrical panel
- Timer (time clock) and On/Off button on the pump
- With 6-way valve
- Monophase
- Top diffuser ensures even distribution of water over the sand bed

USAGE AREAS

















- Swimming pools up to 60 tons
- Children's pools
- Fountain pools
- Irrigation pools
- Landscape sprinkler tanks
- Jacuzzies
- Fish lakes
- Biological pools
- Water treatment pre-filtration
- Waterfalls



KOD CODE	MODEL MODEL	DEBİ m ³ /h FLOW	KUM Kg SAND Kg	
PSFAC58486	11355 L / 3000 GAL	11,50 m ³ /saat	36	534 €





FİLTREASYON BLOKLARI

FILTRATION BLOCKS

	Filter Filtre	Skimfilter Skimfilter	Pompa Pump	Max. Havuz Max. Pool	Makina dairesi Mechanical room
 <p>MODEL: FB 1001-C KOD: CARMAX1ING75M</p> <p> 2.208 €</p>	Kartuş Cartridge	1 Adet 1 Pcs	0,75 Hp Monofaze	45 m ³	✓
	<p>İÇERİK: Kartuş Filtre Yüzey Alanı: 2x1.80 m² Sirkülasyon Pompası: 15.3 m³/h debi 220V Besleme Nozulu: 1 adet Lamba: 1 adet Kumanda Panosu: 1 adet</p> <p>CONTENT: Surface Area Cartridge Filter: 2x1.80 m² Circulation Pump: 15.3 m³/h flow 220V Inlet Nozzle: 1 Pcs Lamp: 1 Pcs Control Panel: 1 Pcs</p>				
 <p>MODEL: FB 1002-C KOD: CARMAX2ING150M</p> <p> 2.323 €</p>	Kartuş Cartridge	1 Adet 1 Pcs	1,50 Hp Monofaze	90 m ³	✓
	<p>İÇERİK: Kartuş Filtre Yüzey Alanı: 4x1.80 m² Sirkülasyon Pompası: 20.4 m³/h debi 220V Besleme Nozulu: 1 adet Lamba: 1 adet Kumanda Panosu: 1 adet</p> <p>CONTENT: Surface Area Cartridge Filter: 2x1.80 m² Circulation Pump: 20.4 m³/h flow 220V Inlet Nozzle: 1 Pcs Lamp: 1 Pcs Control Panel: 1 Pcs</p>				
 <p>MODEL: FB 1003-C KOD: CARMED2ING75M</p> <p> 1.829 €</p>	Kartuş Cartridge	1 Adet 1 Pcs	0,75 Hp Monofaze	45 m ³	Opsiyonel Optional
	<p>İÇERİK: Kartuş Filtre Yüzey Alanı: 2x1.80 m² Sirkülasyon Pompası: 15.3 m³/h debi 220V Besleme Nozulu: 1 adet Lamba: 1 adet Kumanda Panosu: 1 adet</p> <p>CONTENT: Surface Area Cartridge Filter: 2x1.80 m² Circulation Pump: 15.3 m³/h flow 220V Inlet Nozzle: 1 Pcs Lamp: 1 Pcs Control Panel: 1 Pcs</p>				
 <p>MODEL: FB 1004-C KOD: CARMED1TOP75M</p> <p> 1.945 €</p>	Kartuş Cartridge	1 Adet 1 Pcs	0,75 Hp Monofaze	45 m ³	✓
	<p>İÇERİK: Kartuş Filtre Yüzey Alanı: 2x1.80 m² Sirkülasyon Pompası: 15.3 m³/h debi 220V Besleme Nozulu: 1 adet Lamba: 1 adet Kumanda Panosu: 1 adet</p> <p>CONTENT: Surface Area Cartridge Filter: 2x1.80 m² Circulation Pump: 15.3 m³/h flow 220V Inlet Nozzle: 1 Pcs Lamp: 1 Pcs Control Panel: 1 Pcs</p>				
 <p>MODEL: FB 1005-C KOD: CARMIN1ING50M</p> <p> 1.846 €</p>	Kartuş Cartridge	1 Adet 1 Pcs	0,50 Hp Monofaze	20 m ³	Opsiyonel Optional
	<p>İÇERİK: Kartuş Filtre Yüzey Alanı: 1x1.80 m² Sirkülasyon Pompası: 11.7 m³/h debi 220V Besleme Nozulu: 1 adet Kumanda Panosu: 1 adet</p> <p>CONTENT: Surface Area Cartridge Filter: 1x1.80 m² Circulation Pump: 11.7 m³/h flow 220V Inlet Nozzle: 1 Pcs Control Panel: 1 Pcs</p>				
 <p>MODEL: FB 1006-C KOD: CARMIN1TOP50M</p> <p> 1.789 €</p>	Kartuş Cartridge	1 Adet 1 Pcs	0,50 Hp Monofaze	20 m ³	Opsiyonel Optional
	<p>İÇERİK: Kartuş Filtre Yüzey Alanı: 1x1.80 m² Sirkülasyon Pompası: 11.7 m³/h debi 220V Besleme Nozulu: 1 adet Kumanda Panosu: 1 adet</p> <p>CONTENT: Surface Area Cartridge Filter: 1x1.80 m² Circulation Pump: 11.7 m³/h flow 220V Inlet Nozzle: 1 Pcs Control Panel: 1 Pcs</p>				
 <p>MODEL: FB 1001-S KOD: SANMAX1ING75M</p> <p> 2.175 €</p>	Kum Sand	1 Adet 1 Pcs	0,75 Hp Monofaze	45 m ³	Opsiyonel Optional
	<p>İÇERİK: Sirkülasyon Pompası: 15.3 m³/h debi 220V Besleme Nozulu: 1 adet Lamba: 1 adet Kumanda Panosu: 1 adet</p> <p>CONTENT: Circulation Pump: 15.3 m³/h flow 220V Inlet Nozzle: 1 Pcs Lamp: 1 Pcs Control Panel: 1 Pcs</p>				
 <p>MODEL: FB 1002-S KOD: SANMAX21N6150M</p> <p> 2.670 €</p>	Kum Sand	1 Adet 1 Pcs	1,50 Hp Monofaze	90 m ³	Opsiyonel Optional
	<p>İÇERİK: Sirkülasyon Pompası: 15.3 m³/h debi 220V Besleme Nozulu: 1 adet Lamba: 1 adet Kumanda Panosu: 1 adet</p> <p>CONTENT: Circulation Pump: 15.3 m³/h flow 220V Inlet Nozzle: 1 Pcs Lamp: 1 Pcs Control Panel: 1 Pcs</p>				
 <p>MODEL: FB 1003-S KOD: SANMED1ING75M</p> <p> 1.795 €</p>	Kum Sand	1 Adet 1 Pcs	0,75 Hp Monofaze	45 m ³	Opsiyonel Optional
	<p>İÇERİK: Sirkülasyon Pompası: 15.3 m³/h debi 220V Besleme Nozulu: 1 adet Lamba: 1 adet Kumanda Panosu: 1 adet</p> <p>CONTENT: Circulation Pump: 15.3 m³/h flow 220V Inlet Nozzle: 1 Pcs Lamp: 1 Pcs Control Panel: 1 Pcs</p>				

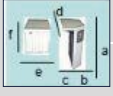
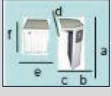
MAKİNA DAİRESİ OLMAYAN HAVUZLARA, MÜKEMMEL ÇÖZÜM! EXCELLENT PRODUCT WITHOUT MACHINE ROOM!

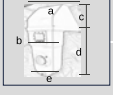
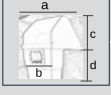
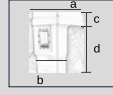
FİLTASYON BLOKLARI TEKNİK ÇİZİMLERİ TECHICAL DETAILS

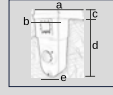
	Model	a	b	c	d	e	f		Model	a	b	c	d	e	f		Model	a	b	c	d	e	f
1001-C	85 cm	30 cm	30 cm	70 cm	60 cm	50 cm		1002-C	85 cm	30 cm	30 cm	70 cm	60 cm	50 cm		1003-C	78 cm	41 cm	10 cm	85 cm	34 cm	--	
	Model	a	b	c	d	e	f		Model	a	b	c	d	e	f		Model	a	b	c	d	e	f
1004-C	78 cm	41 cm	45 cm	85 cm	34 cm	--		1005-C	78 cm	40 cm	45 cm	55 cm	--	--		1006-C	78 cm	40 cm	10 cm	55 cm	--	--	
	Model	a	b	c	d	e	f		Model	a	b	c	d	e	f		Model	a	b	c	d	e	f
1001-S	85 cm	30 cm	30 cm	70 cm	--	--		1002-S	85 cm	30 cm	30 cm	70 cm	--	--		1003-S	78 cm	41 cm	10 cm	85 cm	34 cm	--	

YEDEK KARTUŞ FİLTRE
SPARE PART CARTRIDGE FILTER
FOR FILTRATION BLOCKS

KOD:
CODE: 02099002907

ÖLÇÜ:
SIZE: H: 350 D: 140 D: 60 cm

60 €

FİLTASYON BLOKLARINA İLAVE OPSİYONEL SEÇENEKLER OPTIONAL OPTIONS IN ADDITION TO FILTRATION BLOCKS

Polyester Makina Dairesi Polyester Machine Room	Havuz Temizlik Seti Pool Cleaning Kit	Dezenfeksiyon Cihazları Disinfection Equipments	Havuz Suyu Isıtma Cihazı Pool Heater
<ul style="list-style-type: none">• 70x60 h:50• 100x100 h:90• 140x140 h:105	<ul style="list-style-type: none">• 1 Takım (süpürge, sapı ve hortumu, kepece, fırça, cl-pH test kiti)• 1 set (broom, handle and hose, bucket, brush, cl-pH test kit)	<ul style="list-style-type: none">• Blue Lagon UV-C ultraviyole ile dezenfeksiyon cihazı 40w• Tuz klor jeneratörü SSC mini tuzdan klor üretir• Blue Lagon with UV-C ultraviolet disinfection device 40w• Salt chlorine generator SSC mini produces chlorine from salt	<ul style="list-style-type: none">• Elektrikli Nano SPA Elecra marka 6 kW eşanjör• Electric Nano SPA Elecra brand 6 kW heat exchanger

EKONOMİK, FONKSİYONEL, ESTETİK ECONOMIC, FUNCTIONAL, AESTHETIC

NETAHAVUZ ÜRETİMİDİR
MANUFACTURED BY NETAPOOL



Daha fazla detay için
For more details



BENİ TARA
SCAN ME

ÜRÜNLERİ
WEBSİTESİNDEN
İNCELEMELİK
İÇİN TARATIN

KARTUŞ FİLTRE

CARTRIDGE FILTER



Hassas Filtrasyon
25 Micron
Precision Filtration
25 Micron



Isıtılmı Havuzlarda
Kullanıma Uygun
Can Be Used
For Heated Pools



MAX.
40°



MAX.
2,5 BAR

- 2 adet bağlantı rakorları üzerinde sevk edilir
 - Yoğun kullanıma uygun halka kilit kapak
 - Vidalı hava tahliye tapası
 - UV dayanımlı, açık ortamda montaj edilebilir
 - ABS plastik gövde
 - Kolay montaj
- 2 Pcs unions includes in the box
 - Suitable for intensive use,ring lock cover
 - Manual screw bleeder valve for purging air inside the filter
 - UV resistance body, can be installed outside
 - ABS plastic housing
 - Easy installation



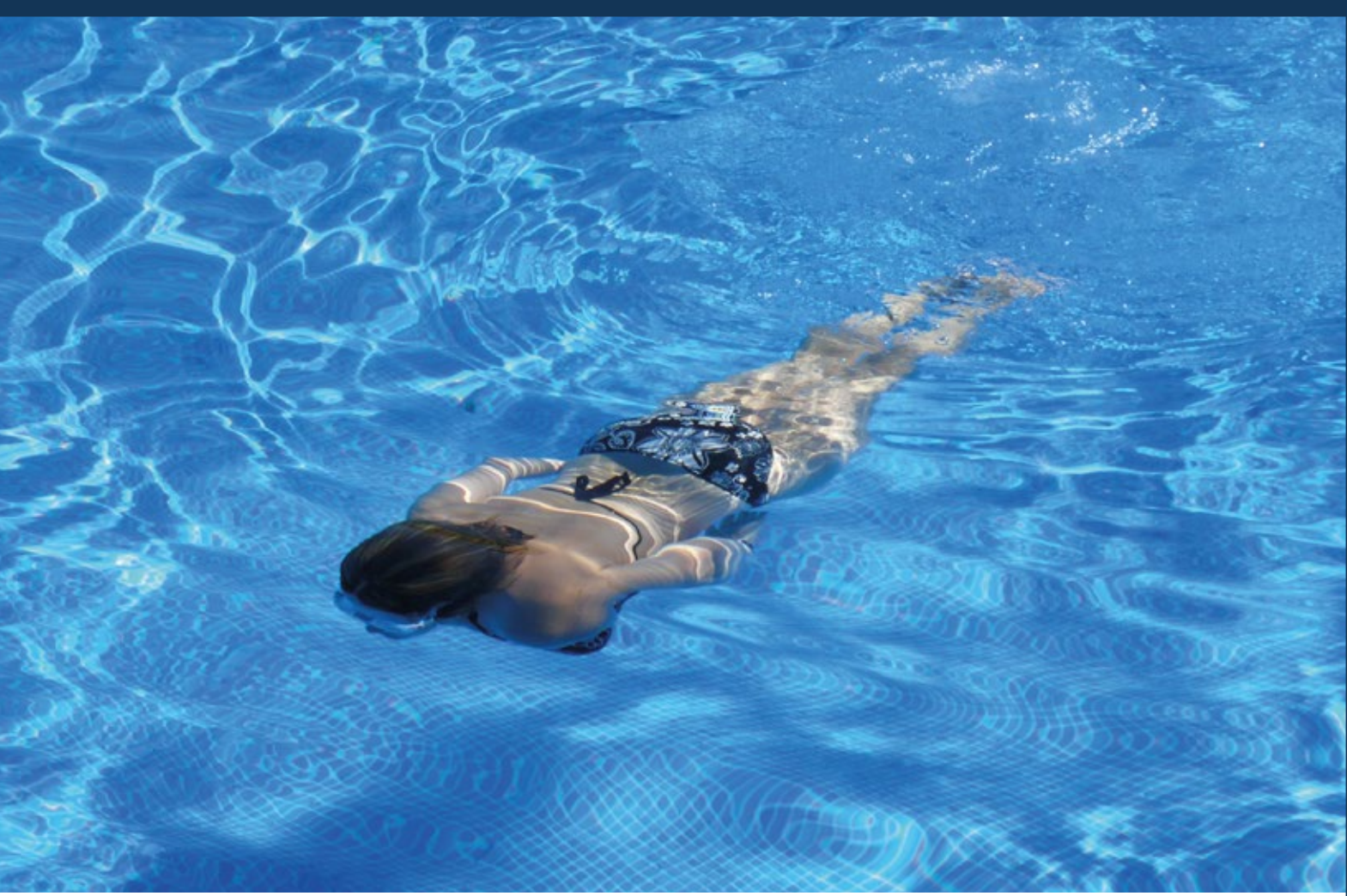

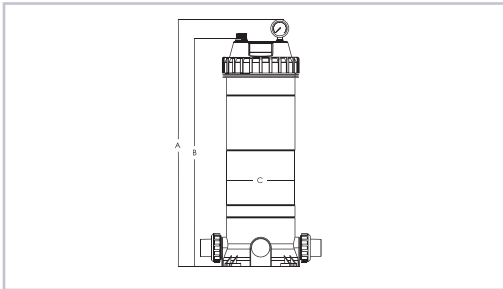

KOD CODE	MODEL MODEL	BAĞLANTI GİRİŞ ÇIKIŞ INLET OUTLET	DEBİ m ³ /h FLOW	
12016123001	KF 25	50 mm	5,50	195 €
12016123002	KF 50	50 mm	11,40	245 €
12016123003	KF 75	50 mm	17,00	290 €
12016123004	KF 100	63 mm	22,90	340 €
12016123005	KF 150	63 mm	33,40	385 €
12016123006	KF 200	63 mm	40,90	475 €

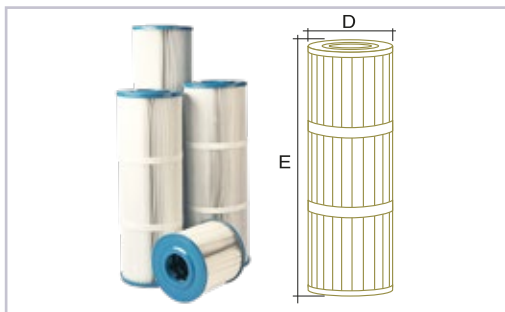

MODEL	A mm	B mm	C mm
KF 25	445	387	225
KF 50	625	567	225
KF 75	805	747	225
KF 100	985	927	225
KF 150	1.165	1.107	225
KF 200	1.345	1.287	225



YEDEK KARTUŞ REPLACEMENT CARTRIDGE FILTER

MODEL	D mm	E mm	MİCRON	KOD CODE	
KF 25	183	184,5	≤ 15	19811123004	45 €
KF 50	183	364,5	≤ 15	19811123005	75 €
KF 75	183	544,5	≤ 15	19811123006	89 €
KF 100	183	724,5	≤ 15	19811123007	93 €
KF 150	183	904,5	≤ 15	19811123008	104 €
KF 200	183	1.091	≤ 15	19811123009	146 €

CAM MEDYA GLASS MEDIA



Türkiye'de Üretilmiştir
Made In Turkey



Daha Uzun Ömürlü
Long Lasting



Daha Uzun Ömürlü
Long Lasting

- Şeffaf pencere camından üretilmiştir, geri dönüşüm şişe içermez
- Üç ayrı çapta üretilmektedir
- Kuvars kuma göre daha uzun ömürlüdür
- Kireçli sularda taşlaşma yapmaz
- Ters yıkamada tam temizleme özelliği
- Kuvars kuma göre %20 daha iyi filtrasyon kapasitesi
- Ters yıkamadan ötürü oluşan su kaybını azaltır
- Enerji ve kimyasal tasarrufu sağlar
- 1 big bag içinde 40x25 kg torba vardır

- Made of transparent pure window glass, do not contain recycling bottles
- Three different granulometry are available
- A longer life span than quartz sand
- In limy water it does not petrified
- Full cleaning feature in backwash
- %20 more filtration capacity than quartz sand
- Saving on backwashing water
- Energy saving and less use of pool chemical
- There are 40x25 kg bags in 1 big bag.



KOD CODE	AMBALAJ PACKING	ÇAP DIAMETER	
12018302001	25	0,5-1,2 mm	20 €
12018302003	25	1,2-3,2 mm	20 €
12018302002	25	3,2-5,0 mm	20 €

KUVARS KUM QUARTZ SAND



Özel Amaçlı Havuz
Residential Pool



Türkiye'de Üretilmiştir
Made In Turkey



Ticari Havuz
Commercial Pool

- Doğal malzemeden üretilmiştir
- Ürün yıkanmış ve fırınlanmıştır
- Yüksek kaliteli ambalaj

- Produced from natural material
- Quartz sand washed and kiln-dried
- High quality package



KOD CODE	AMBALAJ PACKING	ÇAP DIAMETER	
12018132001	25	0,5-1,2 mm	8.75 €
12018132002	25	1-3 mm	8.75 €
12018132003	25	3-5 mm	8.75 €

ZEOLIT ZEOLITE



Türkiye'de Üretilmiştir
Made In Turkey



Enerji Tasarrufu
Energy Saving



Doğal Mineral
Natural Mineral

- Zeolit ,kuvars kum ile karşılaştırıldığında çok berrak bir su üretir
- Yüksek yüzey alanına ve kil ve koloidal partikülleri etkin şekilde filtre edebilen geniş iç boşluk alanına sahip tamamen doğal bir üründür. Temiz ortamdaki basınç düşüşü, tipik silis kumundan daha azdır
- Havuzunuz hep parlak kalır
- Su, enerji, işgücü ve kimyasallarda tasarruf sağlar
- Tüm kum filtrelerinde (hızlı ve yavaş tipler) kuvars yerine kullanılabilir
- İşletme maliyetlerini düşürür
- Ters yıkamayı % 50 azaltır
- Kloraminleri, kokuyu ve göz yanmasını azaltır
- Islak Partikül Yoğunluğu: 1,800 gram/litre
- Tamamen doğaldır

- Produces very clear water compared to quartz sand
- An all-natural zeolite with a high surface area and large internal cavity area that can effectively filter clay and colloidal particles. The pressure drop in clean media is less than typical silica sand
- Your pool always stays bright
- It saves water, energy, labor and chemicals
- Can be used instead of quartz in all sand filters (fast and slow types)
- It reduces operating costs
- Reduces backwashing by 50%
- Reduces chloramines, odor and eye burning
- Wet Particle Density: 1,800 grams/liter
- It is completely natural



KOD CODE	BOYUT mm SIZE mm	
2099003296	0,6 - 1	
2099003297	1 - 2	
2099003298	2 - 4	
2099003299	4 - 7	



MAKİNA DAİRESİ

MACHINE ROOM



POLYESTER MAKİNA DAİRESİ

POLYESTER FILTRATION HOUSING

- Filtrasyon elemanları montajına uygun ergonomik tasarım
 - Cam elyaf takviyeli polyester gövde
 - Çok dayanıklı yapıya sahip
 - UV dayanımlıdır, dış ortamda kullanılabilir
 - 100x100x90 mm; 350-600'lik filtreler için uygundur
 - 140x140x105 mm; 600-900'lük filtreler için uygundur
- Ergonomic design suitable for installation of filtration elements
 - Fibre glass reinforced polyester
 - High durable structure
 - UV resistance, can be installed outside
 - 100x100x90 mm; It is suitable for 350-600 sand filters
 - 140x140x105 mm; It is suitable for 600-900 sand filters



KOD	İÇ ÖLÇÜLER UZUNLUKxGENİŞLİKxYÜKSEKLİK	
CODE	INTERIOR DIMENSIONS LENGHTxWIDTHxHEIGHT	
12017122001	100x100x90	599 €
12017122004	140x140x105	799 €

MAKİNA DAİRESİ KAPAĞI

HOUSING COVER

- Cam takviyeli polyester gövde
 - Çok dayanıklı yapıya sahip
 - UV dayanımlıdır dış ortamda kullanılabilir
 - Gri ve bej renk seçenekleri ile ■■
- Glass reinforced polyester body
 - High durable structure
 - UV resistance, can be installed outside
 - Grey and beige colors optionally ■■



KOD	UZUNLUK cm	GENİŞLİK cm	İÇTEN İÇE	DIŞTAN DIŞA	
CODE	LENGHT cm	WIDTH cm	INTERIOR SIZES	OUTER SIZES	
12017121001	100	100	94x94	112x112	420 €
12017121005	80	80	81x81	104x104	320 €
12017121003	60	60	65x65	90x90	260 €
12017121015	50	50	45x45	58x58	240 €

MAKİNA DAİRESİ MERDİVENİ

POLYESTER FILTRATION HOUSING LADDER

- Cam takviyeli polyester gövde
 - Çok dayanıklı yapıya sahip
 - UV dayanımlıdır dış ortamda kullanılabilir
- Glass reinforced polyester body
 - High durable structure
 - UV resistance, can be installed outside



KOD	UZUNLUK cm	GENİŞLİK cm	BASAMAK	
CODE	LENGHT cm	WIDTH cm	STEP	
12017121002	150	45	4	341 €

POMPA SEHPASI PLASTİK PUMP STAND PLASTIC

- PE plastik enjeksiyon ürün
- Ekonomik alternatif

- PE plastic injection product
- Competitive price



KOD CODE	UZUNLUK cm LENGHT cm	GENİŞLİK cm WIDTH cm	YÜKSEKLİK cm HEIGHT cm	
199002024	41,5	25	19	11 €

POMPA SEHPASI POLYESTER PUMP STAND POLYESTER

- Cam takviyeli polyester gövde
- UV ışınlarına dayanıklı
- Çok dayanıklı yapı

- Glass reinforced polyester body
- UV resistance
- High durable structure



KOD CODE	UZUNLUK cm LENGHT cm	GENİŞLİK cm WIDTH cm	YÜKSEKLİK cm HEIGHT cm	
199002023	46	27	18	57 €

GÖZETLEME CAMI INSPECTION GLASS

- Akrilik şeffaf boru
- U-PVC bağlantı rakoru ile verilir

- Transparent acrylic pipe
- Includes U-PVC unions



KOD CODE	BAĞLANTI CONNECTION	
19811123010	50 mm	21 €
19811123011	63 mm	23.80 €
19811123012	75 mm	60.20 €
19811123013	90 mm	81.20 €
19811123014	110 mm	89.60 €

6 YOLLU VANALAR



- **Praher**, 50 yıllık deneyimi ile Avusturya'da üretilen en yüksek kalite geniş bir ürün yelpazesine sahip
 - **Midas**, 45 yılı aşkın süredir Alman kalitesi ile filtreler için 6 yollu vana üretiyor
 - Filtrenin operasyonunu yönlendirmeyi sağlayan vanalardır
 - Filtrasyon, ters yıkama, durulama, boşaltma, resirkülasyon, kapatma konumları ile 6 fonksiyonu yönetebilmenizi sağlarlar
 - Dişli ve yapıştırma bağlantı opsiyonları mevcuttur. ABS'den mamüldür
- With 50 years of experience, **Praher** has a wide range of top quality products produced in Austria
 - The 6 way **Midas** valves have been produced for pool filter 45 years for over with German quality
 - These are the valves that enable directing the operation of the filter
 - Allow you to manage 6 functions with filtration, backwash, rinse, drain, recirculation, shutdown positions
 - Slip or threaded connections , side or top mounted options are available ABS material (cycolac)



KOD	BAĞLANTI ø mm	GİRİŞ YAPIŞTIRMA	ÇIKIŞ YAPIŞTIRMA	
CODE	CONNECTION ø mm	SLIP INLET	SLIP OUTLET	
168223021	1,5'	Yandan Side	Alttan Lower	



KOD	BAĞLANTI ø mm	GİRİŞ YAPIŞTIRMA	ÇIKIŞ YAPIŞTIRMA	
CODE	CONNECTION ø mm	SLIP INLET	SLIP OUTLET	
168223022	2'	Yandan Side	Alttan Lower	



KOD	BAĞLANTI ø mm	GİRİŞ YAPIŞTIRMA	ÇIKIŞ YAPIŞTIRMA	
CODE	CONNECTION ø mm	SLIP INLET	SLIP OUTLET	
16518223010	1,5'	Yandan Side	Alttan Lower	90 €
16518223011	2'	Yandan Side	Alttan Lower	135 €



KOD	BAĞLANTI ø mm	GİRİŞ DİŞLİ	ÇIKIŞ DİŞLİ	
CODE	CONNECTION ø mm	THREADED INLET	THREADED OUTLET	
168223010	1,5'	Yandan Side	Alttan Lower	95 €
168223015	2'	Yandan Side	Alttan Lower	155 €



KOD	BAĞLANTI ø mm	GİRİŞ DİŞLİ	ÇIKIŞ DİŞLİ	
CODE	CONNECTION ø mm	THREADED INLET	THREADED OUTLET	
168223004	2,5'	Yandan Side	Alttan Lower	445 €



KOD	BAĞLANTI ø mm	GİRİŞ DİŞLİ	ÇIKIŞ DİŞLİ	
CODE	CONNECTION ø mm	THREADED INLET	THREADED OUTLET	
168223003	3'	Yandan Side	Alttan Lower	660 €
168223009	4'	Yandan Side	Alttan Lower	1.869 €

6 WAY VALVES



- Filtrenin operasyonunu yönlendirmeyi sağlayan vanalardır
- Filtrasyon, ters yıkama, durulama, boşaltma, resirkülasyon, kapatma konumları ile 6 fonksiyonu yönetebilmenizi sağlarlar
- Dişli ve yapıştırma bağlantı opsiyonları mevcuttur. ABS'den mamüldür

- These are the valves that enable directing the operation of the filter
- Allow you to manage 6 functions with filtration, backwash, rinse, drain, recirculation, shutdown positions
- Slip or threaded connections , side or top mounted options are available ABS material (cycloc)



KOD CODE	BAĞLANTI ø mm CONNECTION ø mm	GİRİŞ DİŞLİ THREADED INLET	ÇIKIŞ DİŞLİ THREADED OUTLET	
168123001	1,5'	Yandan Side	Alttan Lower	95 €
168123006	1,5'	Yandan Bağlantı Parçalı Side	Alttan Lower	102 €



KOD CODE	BAĞLANTI ø mm CONNECTION ø mm	GİRİŞ DİŞLİ THREADED INLET	ÇIKIŞ DİŞLİ THREADED OUTLET	
168123003	2'	Yandan Side	Alttan Lower	149 €
168123004	2'	Yandan Bağlantı Parçalı Side	Alttan Lower	195 €

Bağlantı parçalı With unions



KOD CODE	BAĞLANTI ø mm CONNECTION ø mm	GİRİŞ DİŞLİ THREADED INLET	ÇIKIŞ DİŞLİ THREADED OUTLET	
168123007	1,5'	Üstten Top	Alttan Lower	80 €



KOD CODE	BAĞLANTI ø mm CONNECTION ø mm	GİRİŞ DİŞLİ THREADED INLET	ÇIKIŞ DİŞLİ THREADED OUTLET	
168123005	2'	Üstten Top	Alttan Lower	102 €

3 YOLLU VANALAR 3 WAY VALVES



- Sistemdeki akış yönünü değiştirmek için kullanılır
- PVC'den üretilmiştir
- Yapıştırma bağlantı: İçten 50 mm, dıştan 63 mm
- Test basıncı 15 bar, çalışma basıncı 10 bardır

- It is used to change the flow direction in the system
- Made of PVC
- Slip Connection: 50 mm inside, 63 mm outside
- Testing pressure in 15 bar, working pressure in 10 bar



KOD CODE	MODEL MODEL	BAĞLANTI Ø mm CONNECTION Ø mm	
16518223003	2,5'	50 / 63	23 €



